

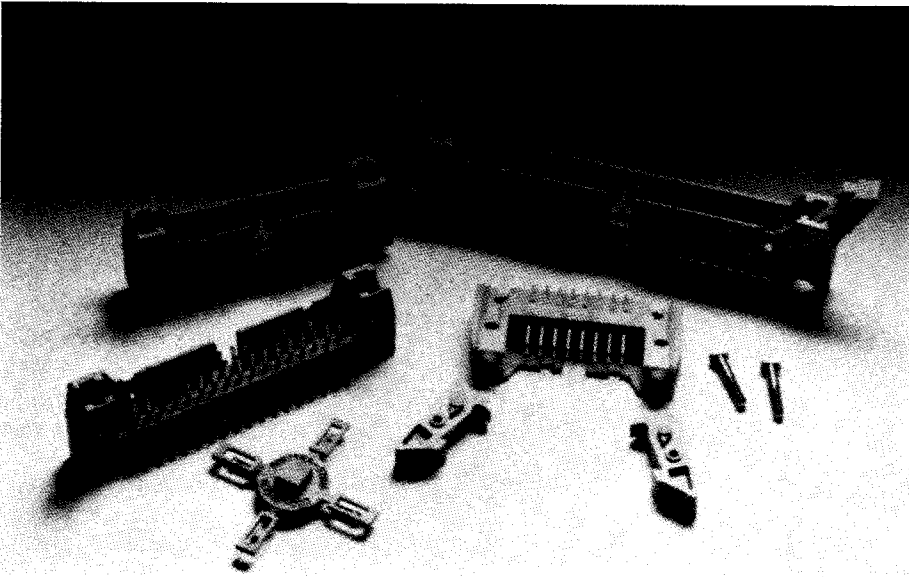

Amphenol® protected headers, three and four sided — 816 series



description

All Amphenol headers are available in both right-angle and straight mounting configurations with three- and four-sided versions. Tail lengths are .100" and .160" in solder tail and .620" in wire wrap styles to meet PC board requirements. Lock and eject latches may be added to reduce strain on cable and PC boards when removing mating socket connectors.

benefits

- MIL-C-83503 compatible
- Snap-in polarization keys
- Easy to install lock & eject latches
- Right-angle and straight mounting styles
- Solder plated tails to avoid solder bath contamination
- Mounting studs option
- UL and CSA recognized 

characteristics

Physical

Contact spacing: .100" × .100"
(2,54mm × 2,54mm) grid
Number of contacts: 10, 14, 16, 20, 26,
30, 34, 36, 40, 50, 60, 64.
Contact material: Phosphor bronze
Contact plating: gold over nickel in
mating area, solder plated tails
Insulation material: Glass reinforced
thermoplastic, UL flammability rating
94 V-O

Electrical

Current rating: 1 amp
Insulation resistance: >5 x 10⁹ ohms at
500 VDC
Dielectric withstanding voltage: 1000
VRMS at sea level
Operating temperature: -55°C to
+105C (-67°F to +221°F)

order information

	842 - 816 -				40	22	- 4	35
number of contacts:	- 10	- 20	- 34	- 60				
	- 14	- 26	- 40	- 64				
	- 16	- 30	- 50					
pin configuration:	3-sided	4-sided						
	27	37	= straight wire-wrap tail					
	29	39	= right angle wire-wrap tail					
	20	30	= straight solder tail for .062 PCB					
	21	31	= straight solder tail for .125 PCB					
	22	32	= right-angle solder tail for .062 PCB					
	23	33	= right-angle solder tail for .125 PCB					
lock & eject (L&E) and mounting stud options:	0 = no L&E, no stud			4 = long L&E, no stud				
	1 = short L&E, no stud			5 = long L&E, short stud				
	2 = short L&E, short stud			6 = long L&E, long stud				
	3 = short L&E, long stud							
plating options:	19 = 15μ gold contact area, tin plated tails							
	35 = 30μ gold contact area, tin plated tails							

Compatible sockets: 842-812, 216

Blue type indicates standard, available product.

Amphenol® protected headers — 816 series

lock and eject and stud options

Latches	H	J	
Short	1.015 (25,8)	.425 (10,8)	For use with socket connectors without strain relief
Long	1.135 (28,8)	.575 (14,6)	For use with socket connectors with strain relief

Part Numbers	
Short Latch	842-800-1607-005
Long Latch	842-800-1607-006
Short Stud	842-800-0309-001
Long Stud	842-800-0309-002

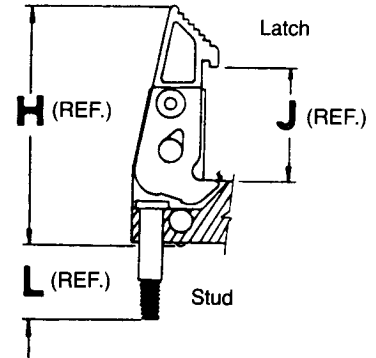

Studs	M	
Short	.27 (6,86)	with short latch — 842-816-XXXX-2XX with long latch — " -5XX
Long	.34 (8,64)	with short latch — " -3XX with long latch — " -6XX

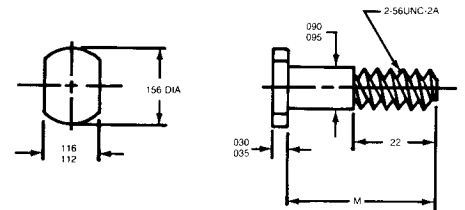

lock and eject installation and polarization tabs

Polarization Tab
Part Number: 842-800-1611-003

recommended mounting hole pattern

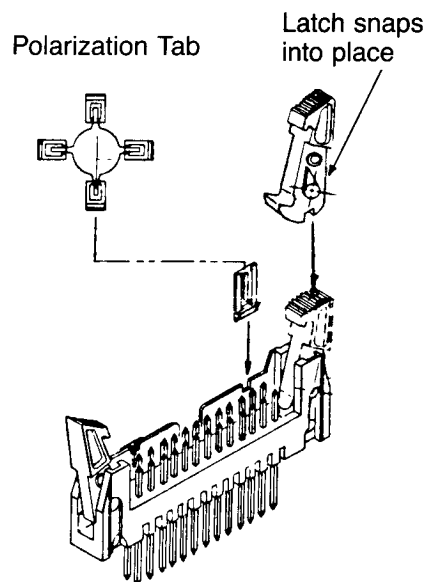
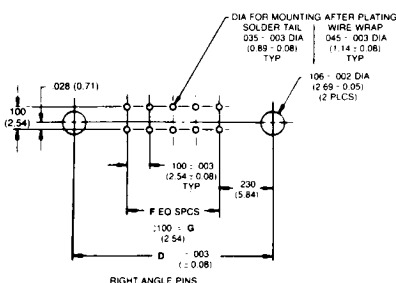
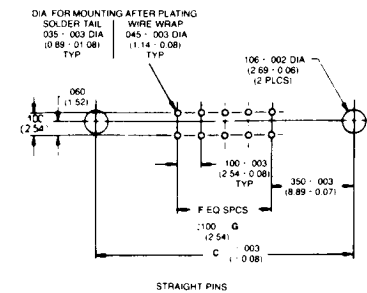

Amphenol[®] protected headers — 816 series

order information — four-sided solder tails, .062 PCB

Pins	Style	Straight Solder Tail .062 PCB	Right-Angle Solder Tail .062 PCB	Dimensions					
				B	C	D	F	G	K
10	No Lock & Eject	842-816-1030-035	842-816-1032-035	1.26	1.100	.860	4	.400	.100
	Short Lock & Eject	842-816-1030-135	842-816-1032-135	(32,00)	(27,94)	(21,84)		(10,16)	(2,54)
	Long Lock & Eject	842-816-1030-435	842-816-1032-435						
14	No Lock & Eject	842-816-1430-035	842-816-1432-035	1.46	1.300	1.060	6	.600	.100
	Short Lock & Eject	842-816-1430-135	842-816-1432-135	(37,84)	(33,02)	(26,92)		(15,24)	(2,54)
	Long Lock & Eject	842-816-1430-435	842-816-1432-435						
16	No Lock & Eject	842-816-1630-035	842-816-1632-035	1.56	1.400	1.160	7	.700	.100
	Short Lock & Eject	842-816-1630-135	842-816-1632-135	(39,62)	(35,56)	(29,46)		(17,78)	(2,54)
	Long Lock & Eject	842-816-1630-435	842-816-1632-435						
20	No Lock & Eject	842-816-2030-035	842-816-2032-035	1.76	1.600	1.360	9	.900	.100
	Short Lock & Eject	842-816-2030-135	842-816-2032-135	(44,70)	(40,64)	(34,54)		(22,86)	(2,54)
	Long Lock & Eject	842-816-2030-435	842-816-2032-435						
26	No Lock & Eject	842-816-2630-035	842-816-2632-035	2.06	1.900	1.660	12	1.200	.100
	Short Lock & Eject	842-816-2630-135	842-816-2632-135	(53,32)	(48,26)	(42,16)		(30,40)	(2,54)
	Long Lock & Eject	842-816-2630-435	842-816-2632-435						
30	No Lock & Eject	842-816-3030-035	842-816-3032-035	2.26	2.100	1.860	14	1.400	.100
	Short Lock & Eject	842-816-3030-135	842-816-3032-135	(57,40)	(53,34)	(47,24)		(35,56)	(2,54)
	Long Lock & Eject	842-816-3030-435	842-816-3032-435						
34	No Lock & Eject	842-816-3430-035	842-816-3432-035	2.46	2.300	2.060	16	1.600	.100
	Short Lock & Eject	842-816-3430-135	842-816-3432-135	(62,48)	(58,42)	(52,32)		(40,64)	(2,54)
	Long Lock & Eject	842-816-3430-435	842-816-3432-435						
40	No Lock & Eject	842-816-4030-035	842-816-4032-035	2.76	2.600	2.360	19	1.900	.100
	Short Lock & Eject	842-816-4030-135	842-816-4032-135	(70,10)	(66,04)	(59,94)		(48,26)	(2,54)
	Long Lock & Eject	842-816-4030-435	842-816-4032-435						
50	No Lock & Eject	842-816-5030-035	842-816-5032-035	3.26	3.100	2.860	24	2.400	.100
	Short Lock & Eject	842-816-5030-135	842-816-5032-135	(82,80)	(78,74)	(72,64)		(60,96)	(2,54)
	Long Lock & Eject	842-816-5030-435	842-816-5032-435						
60	No Lock & Eject	842-816-6030-035	842-816-6032-035	3.76	3.600	3.360	29	2.900	.100
	Short Lock & Eject	842-816-6030-135	842-816-6032-135	(95,90)	(91,44)	(85,34)		(73,66)	(2,54)
	Long Lock & Eject	842-816-6030-435	842-816-6032-435						
64	No Lock & Eject	842-816-6430-035	842-816-6432-035	3.96	3.800	3.560	31	3.100	.100
	Short Lock & Eject	842-816-6430-135	842-816-6432-135	(100,58)	(96,52)	(90,42)		(78,74)	(2,54)
	Long Lock & Eject	842-816-6430-435	842-816-6432-435						

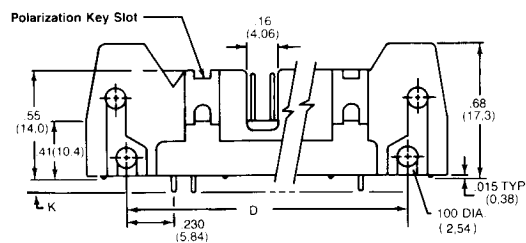

STRAIGHT SHORT SOLDER TAIL 4 SIDED

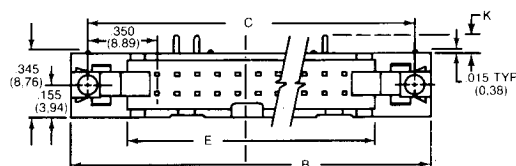

RIGHT ANGLE SHORT SOLDER TAIL 4 SIDED