



73JA10K

73 Series Precision Potentiometer, Wire Wound Element, Solder lug Terminals, 2 W Power Rating, 10 kOhm Resistance Value

Representative photograph, actual product appearance may vary.

Due to regional agency approval requirements, some products may not be available in your area. Please contact your regional Honeywell office regarding your product of choice.

Features

- Robust nickel-plated brass shaft and bushings
- Wirewound element
- Linear taper
- 10-turn construction

Typical Applications

- Manual controls

Description

The 73 Series is a precision type potentiometer made with a wirewound element. It offers 10 turns for higher resolution and accurate output. It has a power rating of 2 watts.



73JA10K

73 Series Precision Potentiometer, Wire Wound Element, Solder lug Terminals, 2 W Power Rating, 10 kOhm Resistance Value

Product Specifications	
Potentiometer Type	Precision
Element Type	Wire Wound
Terminal Type	Solder lug
Power Rating	2 W
Turns	10
Resistance Value	10 kOhm
Resistance Tolerance	± 5 %
Linearity	± 0.25 %
Bushing Thread	9,53 mm [0.375 in] x 32 NEF-2A
Bushing length	7,92 mm [0.312 in]
Bushing Type	Standard
Shaft Diameter	6,35 mm [0.25 in]
Shaft length	20,62 mm [0.812 in]

Shaft Ending	Slotted
Body	22.23 mm [0.875 in] diameter, ± 0.79 mm [0.031 in]
Electrical Taper	Linear
Operating Temperature	-40 °C to 120 °C [-40 °F to 248 °F]
Working Voltage (Max.)	500 V
Rotational Life	50000 cycles
Mechanical Rotation	3600°
Availability	Global
Series Name	73 Series
UNSPSC Code	4111363300
UNSPSC Commodity	4111363300 Potentiometers



73JA10K

73 Series Precision Potentiometer, Wire Wound Element, Solder lug Terminals, 2 W Power Rating, 10 kOhm Resistance Value

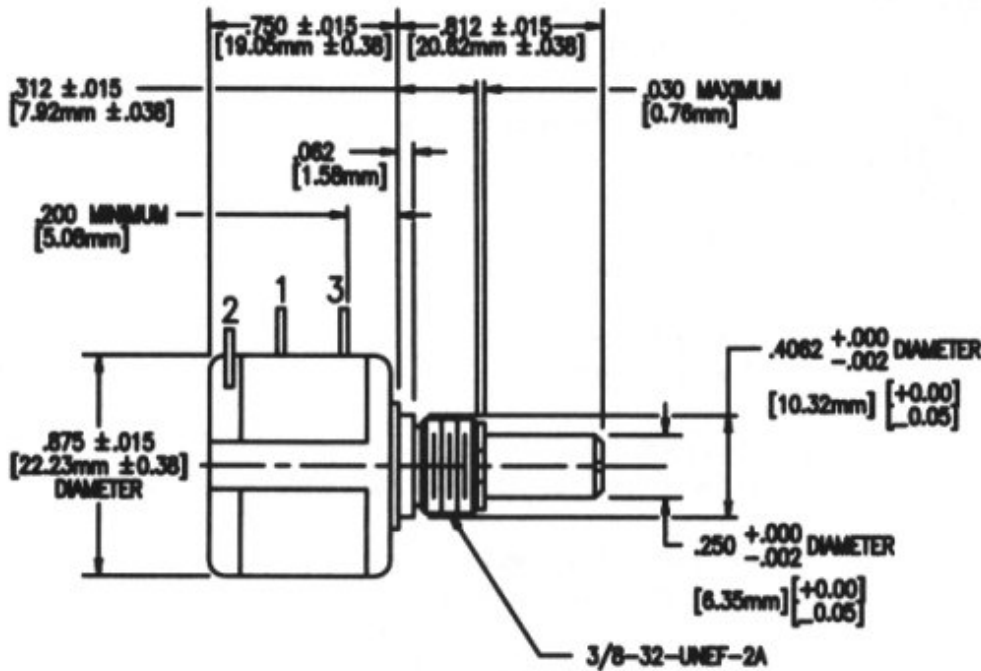

For Reference Only

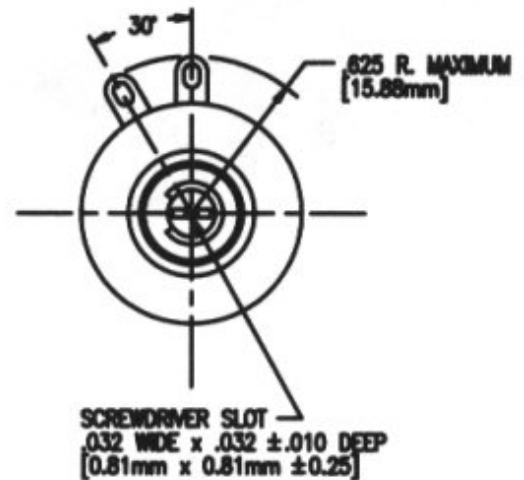

73JA10K

73 Series Precision Potentiometer, Wire Wound Element, Solder lug Terminals, 2 W Power Rating, 10 kOhm Resistance Value

 WARNING

PERSONAL INJURY

DO NOT USE these products as safety or emergency stop devices, or in any other application where failure of the product could result in personal injury.

Failure to comply with these instructions could result in death or serious injury.

 WARNING

MISUSE OF DOCUMENTATION

- The information presented in this product sheet (or catalog) is for reference only. DO NOT USE this document as product installation information.
- Complete installation, operation and maintenance information is provided in the instructions supplied with each product.

Failure to comply with these instructions could result in death or serious injury.

© Copyright Honeywell Inc.1998-2004 All rights reserved.