

# Connector products to simplify wiring



## Contents

Description	Section page
<b>Compact rail and panel mount blocks</b>	
NDN DIN-Rail and C-Rail feed through blocks	2-3
N512, NFT2, NFT3, NC3, NSE3, NSS3 C-Rail feed through blocks	4-5
15188, PLU3, PLU1, PSU1 depluggable DIN-Rail and C-Rail blocks	6-7
KT3, KT4 multi-pole panel mount blocks	7
BNQ21, BQQ41 quick-connect panel mount blocks	8
<b>Power feed through terminal blocks</b>	
C7021 1- to 6-pole block	9
<b>Double row terminal blocks</b>	
TB100 2- to 36-pole blocks	10-11
TB200 and TB200HB 2- to 30-pole blocks	12-13
TB300 and TB345 2- to 24-pole blocks	14-15
<b>Accessories for double row terminal blocks</b>	
Marking options and covers	16
Top and bottom marking strips for terminal blocks	17
<b>Double row terminal blocks continued</b>	
TB400 2- to 12-pole blocks	18
KU 2- to 12-pole blocks	19
<b>Mounting accessories</b>	
End brackets	20
DIN-Rail and C-Rail mounting rails and brackets	

Connector products

## NDN DIN-Rail feed through blocks

The NDN feed through blocks feature a compact line of terminal blocks suitable for both 35mm DIN-Rail or C-Rail applications. Products easily snap onto the mounting rail for a quick, simple, low-cost solution. Available accessories include jumpers and marking tape.

UL E62622

CSA File 15364

CSA File 47235 (NDN1, NDN111)

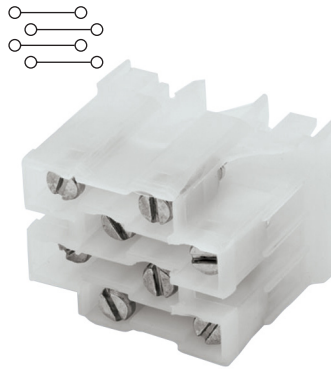

**NDNV4**

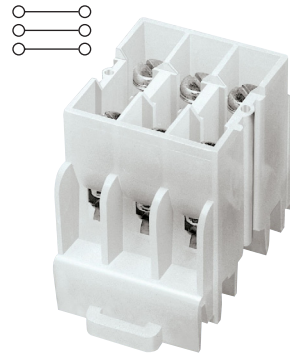

**NDN3**

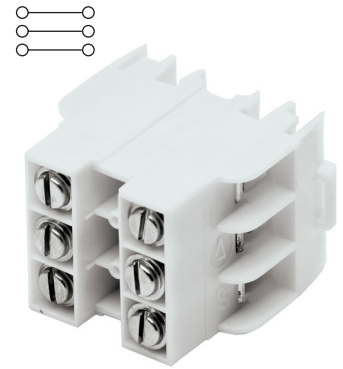

**NDN63**

Approval	
Technical data	
Rated voltage	600V
Rated Current	30A
Center spacing, in (mm)	0.25 / 6.35
Conductor cross-section, flexible (AWG/mm <sup>2</sup> )	22-10 / 0.3-5.3
Number of Poles	4
Circuits per foot	48
Torque(N•m)	2
Torque(lb-in)	18
Screw	#6-32
WxHxD(mm)	25.4 x 34 x 42.4
Colors	Cat. no.
○ White (standard)	NDNV4-WH
● Black	NDNV4-BK
Accessories	Cat. no.
4 circuits	JN4
Marking tape	MTC6
35mm DIN-Rail	DRL35MML DRL35MMHI
C-Rail	NFTA NRA
Dimensions — in (mm)	

Approval	
Technical data	
Rated voltage	600V
Rated Current	30A
Center spacing, in (mm)	0.3 / 7.62
Conductor cross-section, flexible (AWG/mm <sup>2</sup> )	22-10 / 0.3-5.3
Number of Poles	3
Circuits per foot	38
Torque(N•m)	2
Torque(lb-in)	18
Screw	#6-32
WxHxD(mm)	23.9 x 33.3 x 42.4
Colors	Cat. no.
○ White (standard)	NDN3-WH
● Blue	NDN3-BL
Accessories	Cat. no.
2 circuits	JNDN3
Marking tape	MT12-1-2
35mm DIN-Rail	DRL35MML DRL35MMHI
C-Rail	NFTA NRA
Dimensions — in (mm)	

Approval	
Technical data	
Rated voltage	600V
Rated Current	65A
Center spacing, in (mm)	0.375 / 9.52
Conductor cross-section, flexible (AWG/mm <sup>2</sup> )	18-6 / 0.8-13.3
Number of Poles	3
Circuits per foot	30
Torque(N•m)	4
Torque(lb-in)	35
Screw	#10-32
WxHxD(mm)	29.7 x 36.8 x 42.4
Colors	Cat. no.
○ White (standard)	NDN63-WH
● Black	NDN63-BK
Accessories	Cat. no.
2 circuits	JN1
Marking tape	MT12-1-2
35mm DIN-Rail	DRL35MML DRL35MMHI
C-Rail	NFTA NRA
Dimensions — in (mm)	

Block  
Jumper  
Marking tape  
Mounting  
Modular option

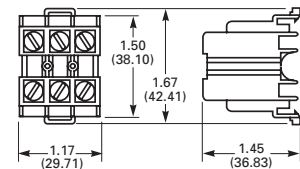
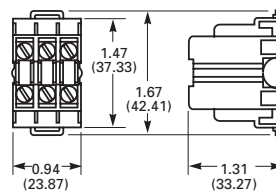
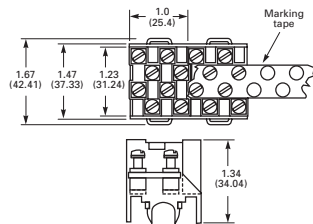

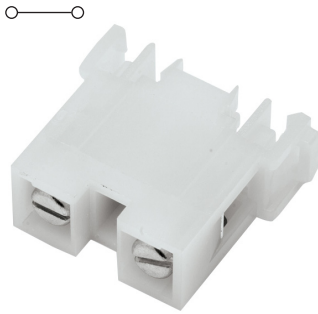

**NDN1**

Approval	
Technical data	
Rated voltage	600V
Rated Current	90A
Center spacing in (mm)	0.635 / 16.31
Conductor cross-section, flexible (AWG/mm <sup>2</sup> )	18-2 / 0.8-33.6
Number of Poles	1
Circuits per foot	18
Torque(N•m)	3.6
Torque(lb-in)	32
Screw	1/4-28
WxHxD(mm)	15 x 30.3 x 43.5
Colors <b>Cat. no.</b>	
○ White (standard)	NDN1-WH
Accessories <b>Cat. no.</b>	
—	—
	MT12-1-2
35mm DIN-Rail	DRL35MML DRL35MMHI
C-Rail	NFTA NRA

**Dimensions — in (mm)**

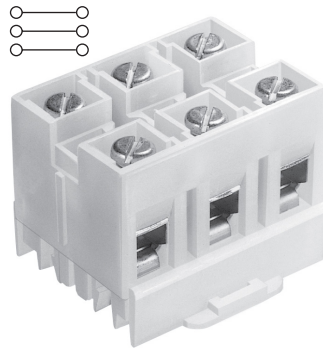
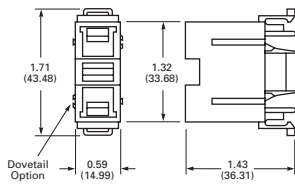

**NDN111**

Approval	
Technical data	
Rated voltage	600V
Rated Current	90A
Center spacing in (mm)	0.635 / 16.31
Conductor cross-section, flexible (AWG/mm <sup>2</sup> )	18-2 / 0.8-33.6
Number of Poles	3
Circuits per foot	18
Torque(N•m)	3.6
Torque(lb-in)	32
Screw	1/4-28
WxHxD(mm)	47.5 x 36.6 x 43.5
Colors <b>Cat. no.</b>	
○ White (standard)	NDN111-WH
● Black	NDN111-BK
Accessories <b>Cat. no.</b>	
2 circuits	JN1
	MT12-1-2
35mm DIN-Rail	DRL35MML DRL35MMHI
C-Rail	NFTA NRA

NDN111A-WH, NDN111A-BK

**Dimensions — in (mm)**

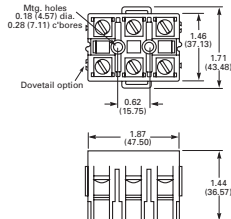

## C-Rail feed through terminal blocks

C-Rail terminal blocks provide a low-profile, compact foot-print solution for various wire connection applications. Products feature an easy, snap-on installation method and an array of accessories including jumpers and marking strips.

UL E62622 (excluding N512)

CSA File 15364

CSA File 47235 (NFT3)

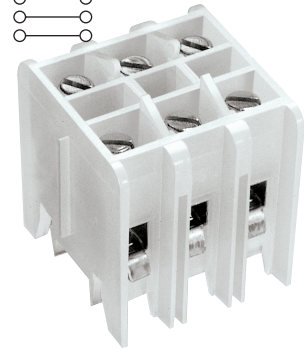
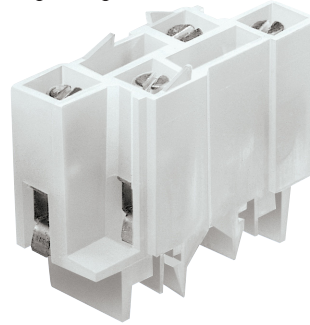
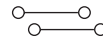
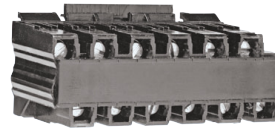

**N512**

Approval	
Technical data	
Rated voltage	300V 600V
Rated current	20A 5A
Center spacing in (mm)	0.197 / 5.0
Conductor cross-section, flexible (AWG/mm <sup>2</sup> )	22-12 / 0.3-3.3
Number of Poles	12
Circuits per foot	60
Torque(N*m)	1.4
Torque(lb-in)	12
Screw	#4-48
WxHxD(mm)	61.0 x 27.7 x 22.4
Colors	Cat. no.
● Black (standard)	N512-BK
—	—
Accessories	Cat. no.
12 circuits	JN512
Marking tape	AT512
Mounting	C-Rail NFTA NRA
Dimensions — in (mm)	

**NFT2**

Approval	
Technical data	
Rated voltage	600V
Rated Current	40A
Center spacing in (mm)	0.28 / 7.13
Conductor cross-section, flexible (AWG/mm <sup>2</sup> )	22-8 / 0.3-8.4
Number of Poles	2
Circuits per foot	38
Torque(N*m)	2
Torque(lb-in)	18
Screw	#8-32
WxHxD(mm)	16.5 x 34.7 x 42.8
Colors	Cat. no.
○ White (standard)	NFT2-WH
—	—
Accessories	Cat. no.
2 circuits	JN2
Marking tape	MT12-1-2
Mounting	C-Rail NFTA NRA
Dimensions — in (mm)	

**NFT3**

Approval	
Technical data	
Rated voltage	600V
Rated Current	40A
Center spacing in (mm)	0.39 / 9.91
Conductor cross-section, flexible (AWG/mm <sup>2</sup> )	22-8 / 0.3-8.4
Number of Poles	3
Circuits per foot	28
Torque(N*m)	2
Torque(lb-in)	18
Screw	#8-32
WxHxD(mm)	30.0 x 32.9 x 31.4
Colors	Cat. no.
○ White (standard)	NFT3-WH
● Black	NFT3-BK
Accessories	Cat. no.
2 circuits	JN3
Marking tape	MT12-1-2
Mounting	C-Rail NFTA NRA
Dimensions — in (mm)	

Block



Jumper

Marking tape

Mounting

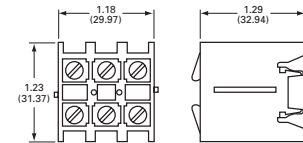
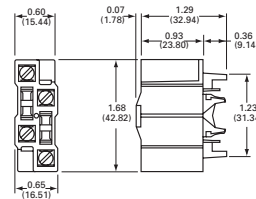
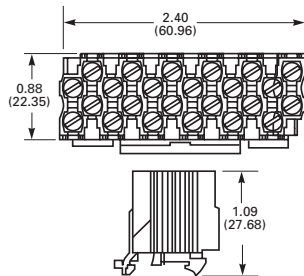



NC3

Approval

**Technical data**

Rated voltage	600V
Rated Current	175A
Center spacing in (mm)	1.06 / 26.92
Conductor cross-section, flexible (AWG/mm <sup>2</sup> )	14-2/0 / 2.1-67.4 Cu/AL
Number of Poles	3
Circuits per foot	11
Torque(N•m)	5.1
Torque(lb-in)	45
Screw	5/16 - 24
WxHxD(mm)	79.4 x 44.5 x 44.5

**Colors** **Cat. no.**

○ White (standard) NC3-WH

**Accessories** **Cat. no.**

—  
MT12-1-2

Panel mount —  
C-Rail NFTA  
NRA

**Dimensions — in (mm)**

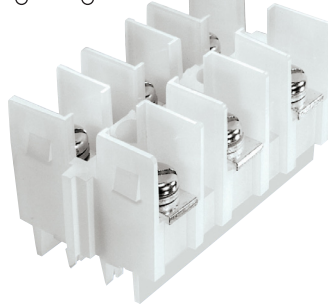
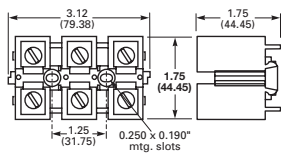

NSE3

Approval

**Technical data**

Rated voltage	600V
Rated Current	115A
Center spacing in (mm)	1.06 / 26.92
Conductor cross-section, flexible (AWG/mm <sup>2</sup> )	Ring terminals only
Number of Poles	3
Circuits per foot	11
Torque(N•m)	3.6
Torque(lb-in)	32
Screw	1/4 - 28
WxHxD(mm)	79.2 x 38.9 x 44.5

**Colors** **Cat. no.**

○ White (standard) NSE3-WH

**Accessories** **Cat. no.**

2 circuits JNSE3  
MT12-1-2

Panel mount —  
C-Rail NFTA Series  
NRA Series

**Dimensions — in (mm)**

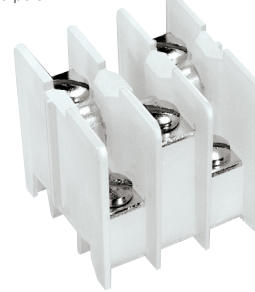
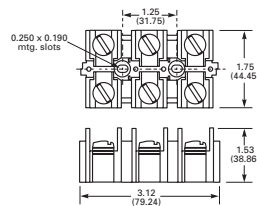

NSS3

Approval

**Technical data**

Rated voltage	600V
Rated Current	30A
Center spacing in (mm)	0.385 / 9.77
Conductor cross-section, flexible (AWG/mm <sup>2</sup> )	Ring terminals only
Number of Poles	3
Circuits per foot	28
Torque(N•m)	1.4
Torque(lb-in)	12
Screw	#6-32
WxHxD(mm)	31.5 x 33.7 x 31.8

**Colors** **Cat. no.**

○ White (standard) NSS3-WH

**Accessories** **Cat. no.**

2 circuits JNSS3  
MT12-1-2

Panel mount —  
C-Rail NFTA  
NRA

**Dimensions — in (mm)**

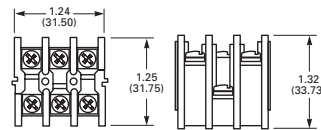

## DIN-Rail depluggable blocks

Depluggable terminal blocks are available for both 35mm DIN-Rail and C-Rail applications. These blocks provide a simple depluggable\* option for panel wiring applications with the convenience of quick, easy, snap-on installation. Product accessories such as jumpers and marking tape are available for most products.

UL E62622

CSA File 15364

CSA File 47235 (15188 Series)

\* Not for use as a load break disconnect.

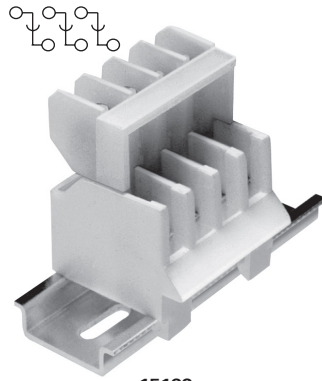

15188

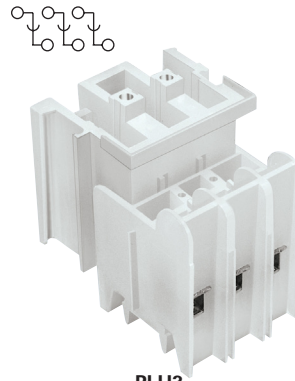

PLU3

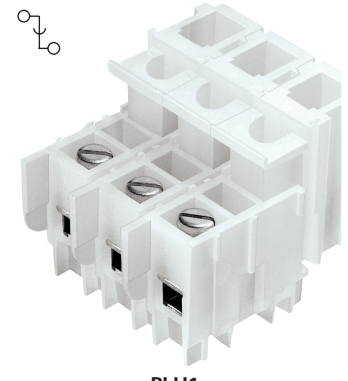

PLU1

Approval	
Technical data	
Rated voltage	600V
Rated Current	30A
Center spacing in (mm)	0.375 / 9.52
Conductor cross-section, flexible (AWG/mm <sup>2</sup> )	16-12 / 1.3-3.3
Number of Poles	3 or 4
Circuits per foot	32
Torque(N*m)	1.4
Torque(lb-in)	12
Screw	#6-32
3-Pole	WxHxD(mm) 30.2 x 49.3 x 47.8
4-Pole	39.2 x 49.3 x 47.8
Colors	Cat. no.
○ White (standard)	15188-3
○ White (standard)	15188-4
Accessories	Cat. no.
2 circuits	15188J-2-J, J15188
—	
Mounting	35mm DIN-Rail DRL35MMLO DRL35MMHI
Configurable Option	Reverse Wiring 15188_-R Locking 15188_-S Reverse; Locking 15188_-RS



Block

Jumper

Marking tape

Mounting

Configurable Option

Options offered for both pole lengths

### Dimensions — in (mm)

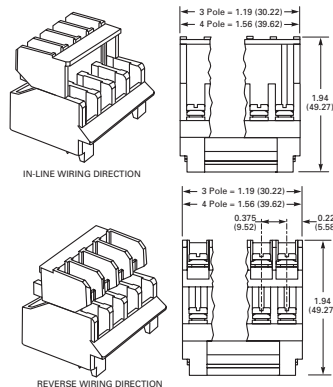

Approval	
Technical data	
Rated voltage	600V
Rated Current	40A
Center spacing in (mm)	0.39 / 9.91
Conductor cross-section, flexible (AWG/mm <sup>2</sup> )	22-8 / 0.3-8.4
Number of Poles	3
Circuits per foot	28
Torque(N*m)	2
Torque(lb-in)	18
Screw	#8-32
3-Pole	WxHxD(mm) 31.8 x 47.0 x 45.6
Colors	Cat. no.
○ White (standard)	PLU3-WH
● Black	PLU3-BK
Accessories	Cat. no.
2 circuits	JN3
—	
C-Rail (AL)	NFTA NRA

### Dimensions — in (mm)

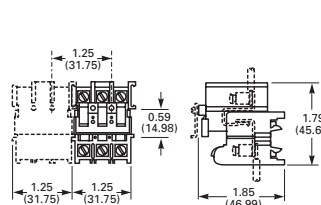

Approval	
Technical data	
Rated voltage	600V
Rated Current	70A
Center spacing in (mm)	0.3 / 7.62
Conductor cross-section, flexible (AWG/mm <sup>2</sup> )	18-4 / 0.8-21.2
Number of Poles	1 - 3
Circuits per foot	19
Torque(N*m)	3.6
Torque(lb-in)	32
Screw	1/4 - 28
1-Pole	WxHxD(mm) 18.5 x 47.0 x 45.6
2-Pole	34.0 x 47.0 x 45.6
3-Pole	49.5 x 47.0 x 45.6
Colors	Cat. no.
○ White (1-Pole)	PLU1-WH
○ White (2-Pole)	PLU11-WH
○ White (3-Pole)	PLU111-WH
Accessories	Cat. no.
2 circuits	JN1
—	
C-Rail (AL)	NFTA NRA

### Dimensions — in (mm)

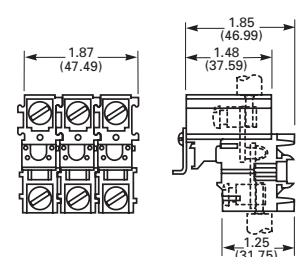

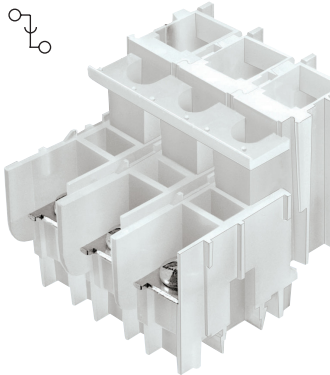

PSU1

**Panel mount multi-pole blocks**

Multi-pole panel mount terminal blocks provide a compact, high density circuit connection solution without the necessity of a mounting rail. These products are designed to be nested together to form one string of circuit connections.

UL E62622  
CSA 15364

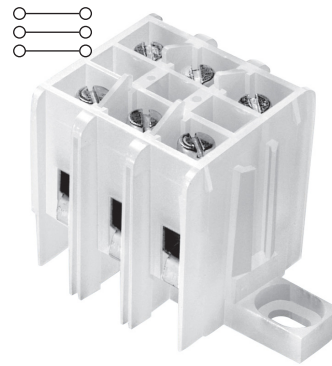

KT3

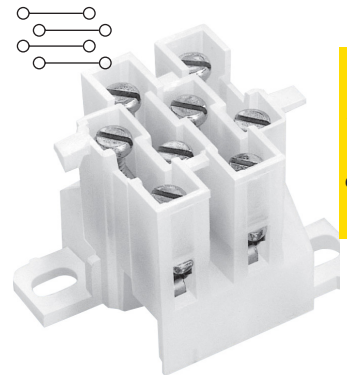

KT4

Connector products

Approval	
----------	--

**Technical data**

Rated voltage	600V
Rated Current	45A
Center spacing in (mm)	0.625 / 15.88
Conductor cross-section, flexible (AWG/mm <sup>2</sup> )	Ring terminals only
Number of Poles	1 - 3
Circuits per foot	19
Torque(N•m)	2.7
Torque(lb-in)	24
Screw	#10-32

3-Pole	WxHxD(mm) 50.3 x 49.1 x 62.1
--------	---------------------------------

**Colors** **Cat. no.**

○ White (3-Pole)	PSU111-WH
------------------	-----------

**Accessories** **Cat. no.**

—	—
---	---

C-Rail (AL)	NFTA NRA
-------------	-------------

**Dimensions — in (mm)**

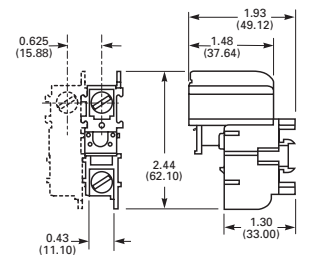

- Block
- Jumper
- Marking tape
- Mounting

Approval	
----------	--

**Technical data**

Rated voltage	600V
Rated Current	40A
Center spacing in (mm)	0.39 / 9.91
Conductor cross-section, flexible (AWG/mm <sup>2</sup> )	22-8 / 0.3-8.4
Number of Poles	3
Circuits per foot	28
Torque(N•m)	2
Torque(lb-in)	18
Screw	#8-32
WxHxD(mm)	59.5 x 31.8 x 31.0

**Colors** **Cat. no.**

○ White (standard)	KT3-WH
--------------------	--------

**Accessories** **Cat. no.**

2 circuits	JN3
------------	-----

—	MT12-1-2
---	----------

Panel mount	—
• Mounting foot	KAD

**Dimensions — in (mm)**

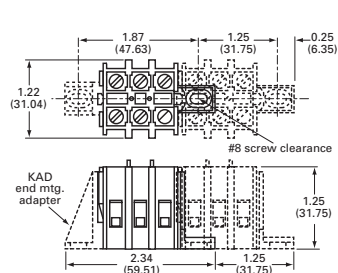

Approval	
----------	--

**Technical data**

Rated voltage	600V
Rated Current	30A
Center spacing in (mm)	0.25 / 6.35
Conductor cross-section, flexible (AWG/mm <sup>2</sup> )	22-10 / 0.3-5.3
Number of Poles	4
Circuits per foot	48
Torque(N•m)	2
Torque(lb-in)	18
Screw	#6-32
WxHxD(mm)	43.8 x 34.0 x 32.2

**Colors** **Cat. no.**

○ White	KT4-WH-A*
---------	-----------

○ White	KT4-WH-B*
---------	-----------

**Accessories** **Cat. no.**

4 circuits	JN4
------------	-----

—	MTC6
---	------

Panel mount	—
-------------	---

**Dimensions — in (mm)**

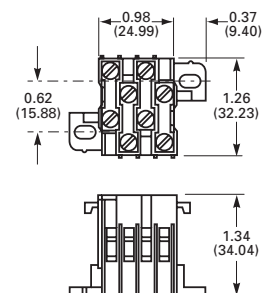

\* The KT4 products are designed to be nested together to form one string of circuit connectors. When used in series, order catalog numbers KT4-WH-A and KT4-WH-B.

## Panel mount quick-connect blocks

A time saving alternative for electrical connections, the Bussmann series quick-connect terminal blocks offer a convenient solution. With male spade terminals, wire connections are made quickly and simply with these terminal blocks.

UL E62622

CSA 15364

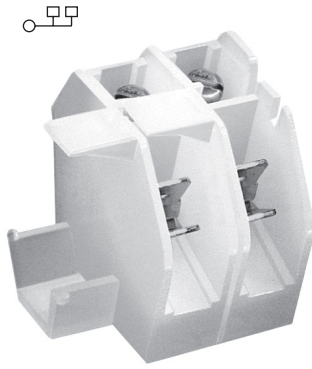

**BNQ21**

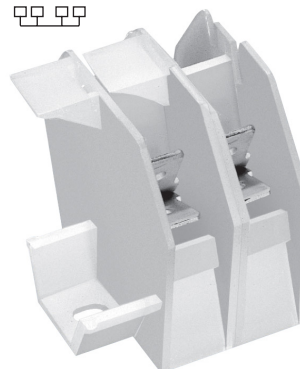

**BQQ41**

Approval	
Technical data	
Rated voltage	600V
Rated Current	40A
Center spacing in (mm)	0.437 / 11.1
Conductor cross-section, flexible (AWG/mm <sup>2</sup> )	22-8 / 0.3-8.4
Number of Poles	1
Circuits per foot	24
Torque(N*m)	2
Torque(lb-in)	18
Screw	#8-32
WxHxD(mm)	33.3 x 35.8 x 37.3
Colors <b>Cat. no.</b>	
○ White (standard)	BNQ21-WH
Accessories <b>Cat. no.</b>	
—	—
Panel mount	—
• Mounting foot	BQE
Dimensions — in (mm)	

Approval	
Technical data	
Rated voltage	600V
Rated Current	30A
Center spacing in (mm)	0.437 / 11.1
Conductor cross-section, flexible (AWG/mm <sup>2</sup> )	0.25" Quick-connect terminals only
Number of Poles	1
Circuits per foot	24
Torque(N*m)	NA
Torque(lb-in)	NA
Screw	NA
WxHxD(mm)	33.3 x 35.8 x 37.3
Colors <b>Cat. no.</b>	
○ White (standard)	BQQ41-WH
Accessories <b>Cat. no.</b>	
—	—
Panel mount	—
• Mounting foot	BQE
Dimensions — in (mm)	

Block



Mounting

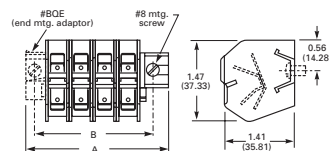
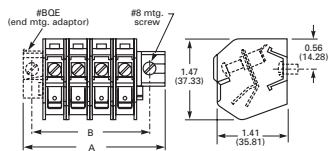



**C7021 power feed through terminal blocks**

Power feed through terminal block with two rows 1/4-20 studs capable of accommodating the industry standard two-hole compression lugs on both studs in parallel.



**Ratings**

- Volts 300 V
- Amps 115/175 A\* per pole
- \* 175 achieved using both studs in parallel, 115 A using a single stud per line.

**Agency information**

- cURus, Guides XCFR2, XCFR8, File E62622
- CE

**Specifications**

- Poles: 1- to 6
- Wire range: AWG #3/0-8
- Center spacing: 0.69" (18mm)
- Bolt hole spacing: 0.625" or 5/8" (16mm)
- Stud: Standard 1/4-20 stud (tin-plated brass) or optional M6 stud.
- Mounting: #6 thread cutting screws (not included) or optional mounting ends.
- Torque: 36 lb-in.
- Operating temperature: 130°C (266°F) max.

**Typical applications**

- Applications requiring up to 175 A utilizing a 2-hole compression lug on 5/8" centers
- Input/output block for telecommunications power panels
- To eliminate busbars

**Dimensions — mm (in)**

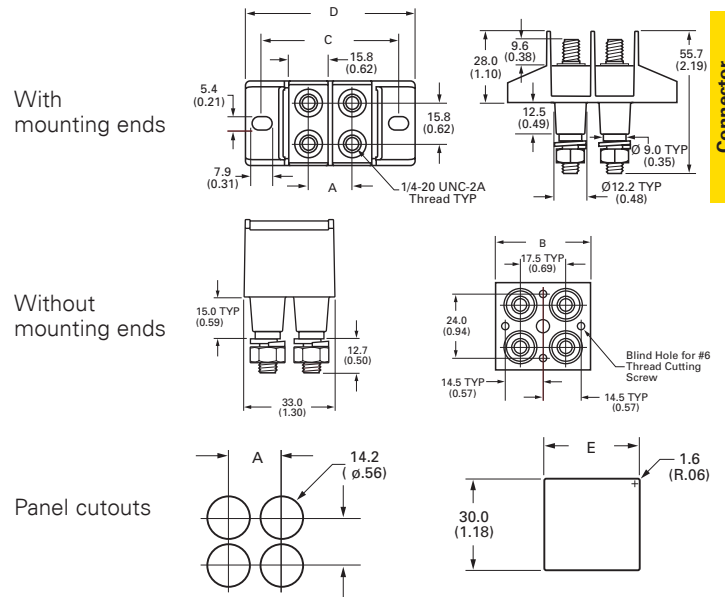

Connector products

Catalog no.	A	B	C	D	E
<b>C7021-01-X with mounting ends</b>					
C7021-02-X	17.5 (0.69)	—	54.4 (2.14)	67.3 (2.65)	31.8 (1.25)
C7021-03-X	34.9 (1.37)	—	70.9 (2.83)	84.8 (3.34)	49.2 (1.94)
C7021-04-X	52.3 (2.06)	—	89.3 (3.52)	102.2 (4.02)	66.7 (2.63)
C7021-05-X	69.8 (2.75)	—	106.8 (4.20)	119.7 (4.71)	84.2 (3.31)
C7021-06-X	87.2 (3.44)	—	124.2 (4.89)	134.1 (5.40)	101.7 (4.00)
<b>C7021-01N-X without mounting ends</b>					
C7021-02N-X	17.5 (0.69)	36.1 (1.42)	—	—	31.8 (1.25)
C7021-03N-X	34.9 (0.69)	53.5 (2.11)	—	—	49.2 (1.94)
C7021-04N-X	52.3 (2.06)	71.0 (2.80)	—	—	66.7 (2.63)
C7021-05N-X	69.8 (2.75)	88.4 (3.48)	—	—	84.2 (3.31)
C7021-06N-X	87.2 (3.44)	105.9 (4.17)	—	—	101.7 (4.00)

**Catalog number build-a-code**

Symbol	Poles	Mount ends	Studs	Hardware
<b>C7021</b>				—
	<b>01</b> = 1-pole (2 studs)	<b>Blank</b> = Mount ends	<b>Blank</b> = Standard	<b>Blank</b> = No hardware
	<b>02</b> = 2-pole (4 studs)	<b>N</b> = No mount ends	<b>M6</b> = M6 studs	<b>0</b> = Bulk pack, one set
	<b>03</b> = 3-pole (6 studs)			<b>1</b> = Bulk pack, two sets
	<b>04</b> = 4-pole (8 studs)			<b>2</b> = Assembled, bottom
	<b>05</b> = 5-pole (10 studs)			<b>3</b> = Assembled, top
	<b>06</b> = 6-pole (12 studs)			<b>4</b> = Assembled, both sets

## TB100 double row terminal blocks

### Ratings\*

- 300 V
- 30 A
- Breakdown voltage: 3600 V

\* Maximum rating shown; some options may be rated lower.

### Agency information

- UL File E62622/CSA File 47235; IEC Compliance

### Specifications

- Poles: 2 to 36
- Center spacing: 0.375" or 3/8" (10mm)
- Wire range: 14-22 AWG Cu
- Screw size: #6-32 phil-slot screws
- Torque rating: 9 lb-in
- Distance between barriers: 0.30" (8mm)
- Mounting: #6 screws
- Operating temperature: -40°C to 130°C (-40°F to 266°F)

### Materials

- Molded black thermoplastic base, UL rated 94V0
- Tin-plated brass terminals
- Zinc-plated steel screws



### Dimensions — in

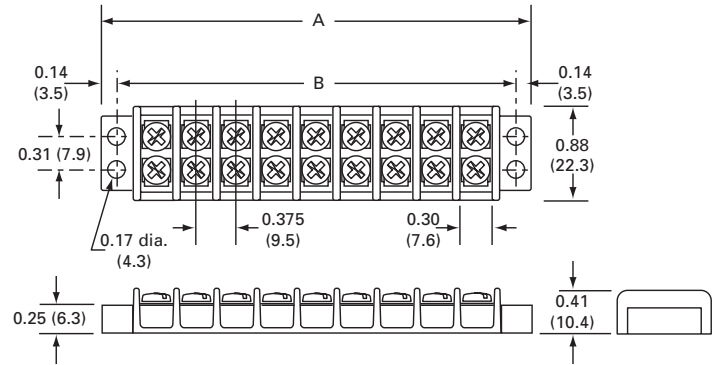

Poles	A	B	Poles	A	B	Poles	A	B
02	1.40	1.12	14	5.90	5.62	26	10.40	10.12
03	1.78	1.50	15	6.28	6.00	27	10.78	10.50
04	2.16	1.88	16	6.66	6.38	28	11.16	10.88
05	2.53	2.25	17	7.03	6.75	29	11.53	11.25
06	2.90	2.62	18	7.40	7.12	30	11.90	11.62
07	3.28	3.00	19	7.78	7.50	31	12.28	12.00
08	3.66	3.38	20	8.16	7.88	32	12.66	12.38
09	4.03	3.75	21	8.53	8.25	33	13.03	12.75
10	4.40	4.12	22	8.90	8.62	34	13.40	13.12
11	4.78	4.50	23	9.28	9.00	35	13.78	13.50
12	5.16	4.88	24	9.66	9.38	36	14.16	13.88
13	5.53	5.25	25	10.03	9.75			

1" = 25.4mm.

### Catalog number build-a-code

Symbol	Poles	Screw options	Marking/cover	Hardware options
TB100	—			
	<b>02 to 36</b>	<b>Blank</b> = steel phil-slot, zinc-plated <b>00</b> = screws shipped bulk <b>B</b> = brass phil-slot, nickel-plated <b>SP</b> = steel SEMS phil-slot, zinc-plated	<b>L1 to L6</b> Marking options, see page 10-16 Special markings <sup>†</sup> , see page 10-16	<b>QC1 to QC20</b> = Quick-connects <b>Custom options<sup>†</sup></b> <b>J101</b> = flat slip-on jumper (2 position only) <b>OJ2</b> = over barrier jumpers <b>OJ4</b> = over barrier jumpers

<sup>†</sup> Contact factory for configuration.

### Accessories

- Marker strips, see page 10-17
- Covers, see page 10-16

**Screw options**



**B**

Brass phil-slot, nickel-plated  
**F502-J** (bulk)

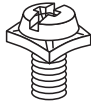

**SP**

Steel SEMS phil-slot, zinc-plated  
**B001-7021-J** (bulk)

**Hardware options**

Quick-connects — assembled: 0.187" x 0.020" terminals, 13 amps maximum. For other orientations, contact factory.

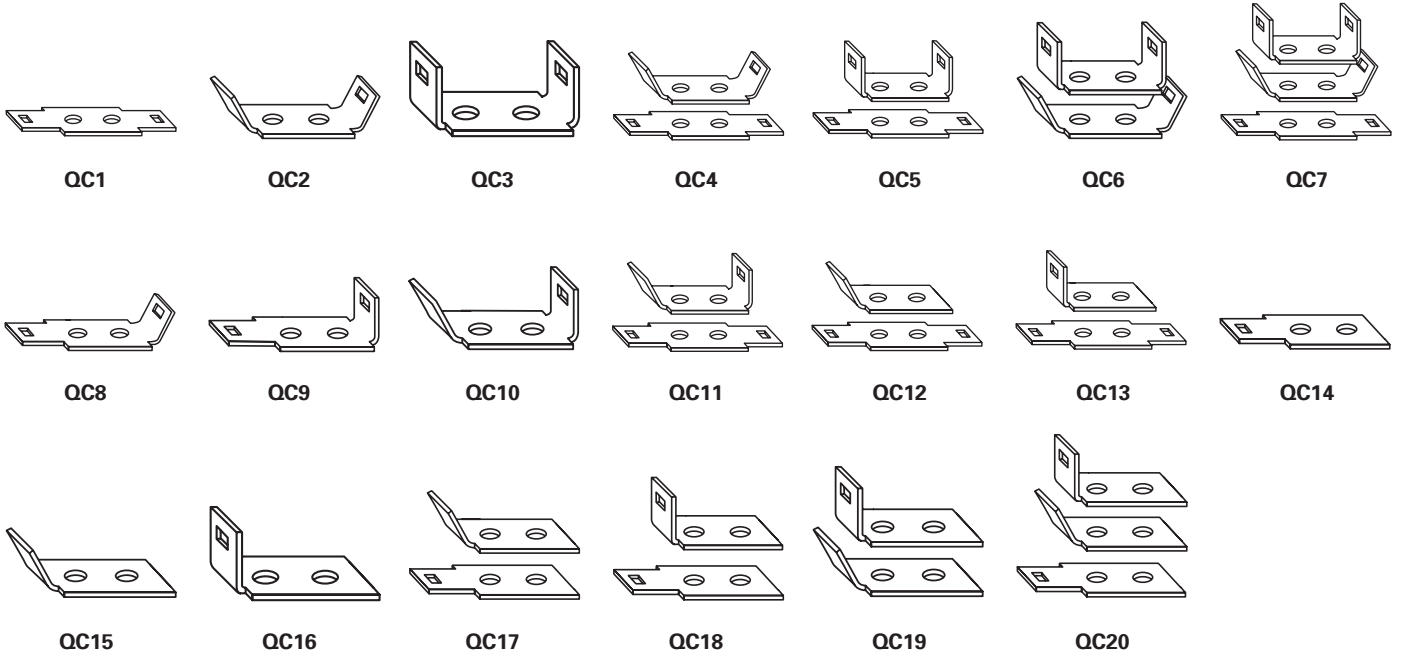

Quick-connects — bulk: minimum order 100 pieces per catalog number.

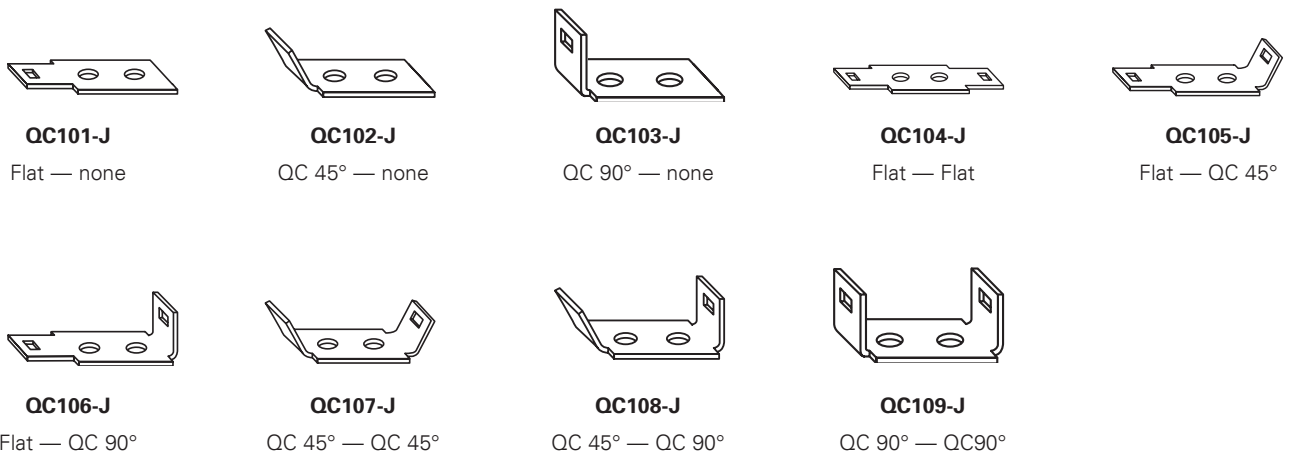

Jumpers — bulk: minimum order 100 pieces per catalog number. Contact factory for jumper assembly.

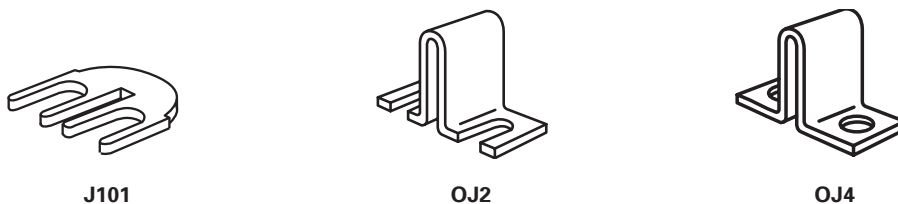

**J101** Flat slip-on (bulk: **J101-J**)      **OJ2** Slip-on over barrier (bulk: **OJ2-J**)      **OJ4** Closed over barrier (bulk: **OJ4-J**)

## TB200 and TB200HB double row terminal blocks

### Ratings\*

- Volts
  - 300 V (TB200)
  - 600 V (TB200HB)
- Amps 30 A
- Breakdown voltage 4800 V
- \* Maximum rating shown; some options may be rated lower.

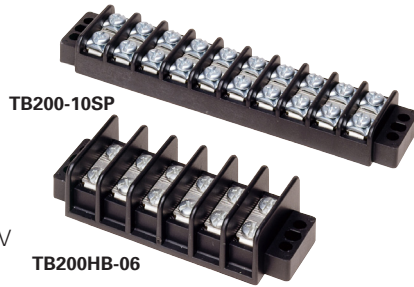

### Agency information

- UL File E62622, CSA File 47235 and 15364; IEC Compliance

### Specifications

- Poles: 2 to 30
- Wire range: 12 - 22 AWG Cu
- Center spacing: 0.437" or 7/16" (11mm)
- Distance between barriers: 0.353" (9mm)
- Screw size: #6-32 phil-slot screws
- Torque rating: 9 lb-in
- Mounting: #6 screws
- Operating temperature: -40°C to 130°C (-40°F to 266°F)

### Materials

- Molded black thermoplastic base UL rated 94V0
- Terminal plating: Tin-plated brass terminals
- Zinc-plated steel screws

### Dimensions — in

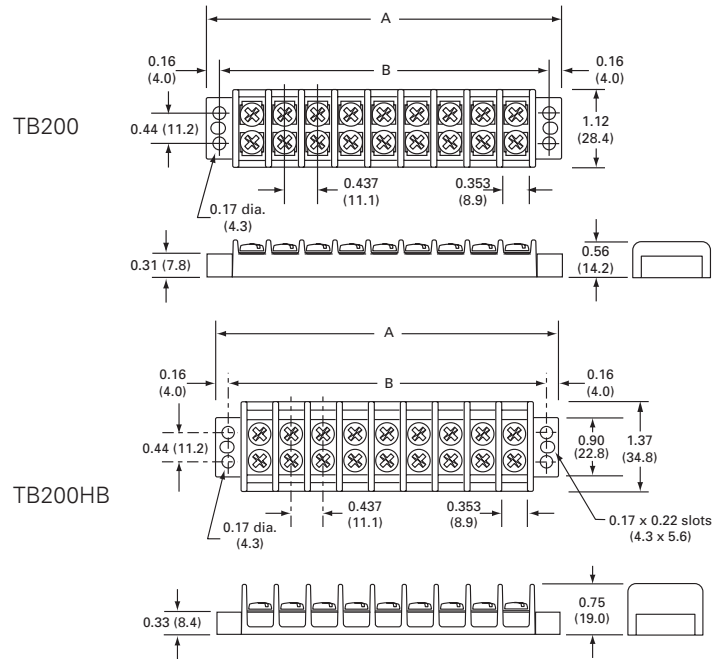

Poles	A	B	Poles	A	B	Poles	A	B
02	1.63	1.31	12	6.00	5.68	22	10.37	10.06
03	2.07	1.75	13	6.44	6.12	23	10.81	10.50
04	2.51	2.18	14	6.87	6.56	24	11.25	10.93
05	2.94	2.62	15	7.31	7.00	25	11.68	11.37
06	3.38	3.06	16	7.75	7.43	26	12.12	11.81
07	3.82	3.50	17	8.19	7.87	27	12.56	12.25
08	4.25	3.93	18	8.62	8.31	28	13.00	12.68
09	4.69	4.37	19	9.06	8.75	29	13.44	13.12
10	5.13	4.81	20	9.50	9.18	30	13.87	13.56
11	5.57	5.25	21	9.94	9.62			

1" = 25.4mm.

### Catalog number build-a-code

Symbol	Barrier style	Poles	Screw options	Marking/cover	Hardware options
TB		—			
	200 = Standard	02 to 30	Blank = Steel phil-slot, zinc-plated	L1 to L6 = Marking options, see page 10-16	QC1 to QC20 = Quick-connects
	200HB = High barrier		00 = Screws shipped bulk	Special markings†, see page 10-16	<b>Custom options<sup>†</sup></b>
			B = Brass phil-slot, nickel-plated		J201 = Flat slip-on jumper, 2 position only
			BS = Brass SEMS phil-slot, nickel-plated		0J3 = Over barrier jumpers
			P = Steel SEMS (P-style)		0J5 = Over barrier jumpers
			SP = Steel SEMS phil-slot, zinc-plated		0J7 = Over barrier jumpers
			SS = Stainless steel SEMS, phil-slot		
			ST = Stainless steel, phil-slot		

† Contact factory for configuration.

### Accessories

- Marker strips, see page 10-17
- Covers, see page 10-16

**Screw options**



**B**

Brass phil-slot  
nickel-plated  
**B001-7016-J** (bulk)

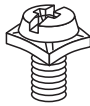

**BS**

Brass SEMS phil-slot  
nickel-plated  
**B001-7019-J** (bulk)

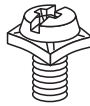

**SP**

Steel SEMS phil-slot  
zinc-plated  
**B001-7007-J** (bulk)

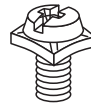

**P**

Steel SEMS  
(P-style)  
**B001-7000-J** (bulk)



**ST**

Stainless steel phil-slot  
**F507-J** (bulk)

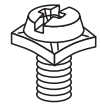

**SS**

Stainless steel SEMS  
phil-slot  
**B001-7085-J** (bulk)

**Hardware options**

Quick-connects — assembled: 0.25" x 0.031" terminals, 20 amps maximum. For other orientations, contact factory.

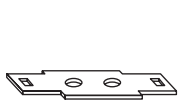

**QC1**

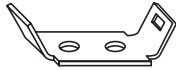

**QC2**

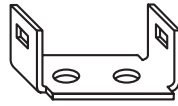

**QC3**

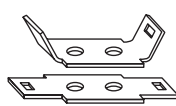

**QC4**

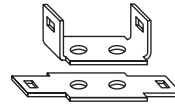

**QC5**

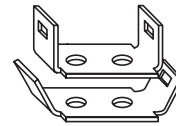

**QC6**

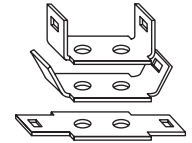

**QC7**

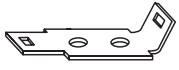

**QC8**

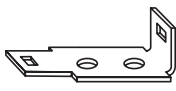

**QC9**

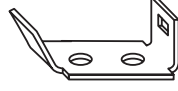

**QC11**

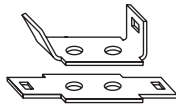

**QC10**

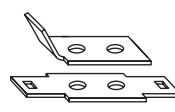

**QC12**

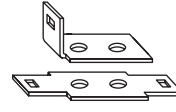

**QC13**



**QC14**

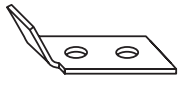

**QC15**

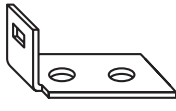

**QC16**

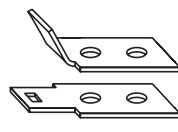

**QC17**

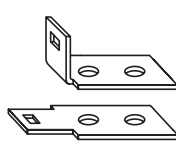

**QC18**

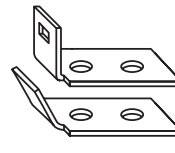

**QC19**

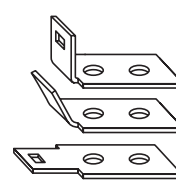

**QC20**

Quick-connects — bulk: minimum order 100 pieces per catalog number.



**QC201-J**

QC 45° — blank



**QC202-J**

Flat — blank

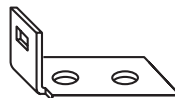

**QC203-J**

QC 90° — blank



**QC204-J**

Flat — Flat



**QC205-J**

Flat — QC 45°



**QC206-J**

Flat — QC 90°



**QC207-J**

QC 45° — QC 45°

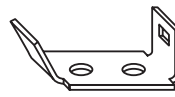

**QC208-J**

QC 45° — QC 90°

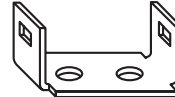

**QC209-J**

QC 90° — QC 90°

Jumpers — bulk: minimum order 100 pieces per catalog number. Contact factory for jumper assembly.



**J201**

Flat slip-on  
(not available on TB200HB)  
**J201-J** (bulk)

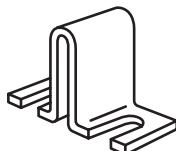

**OJ3**

Slip-on over barrier for TB200HB  
**OJ3-J** (bulk)

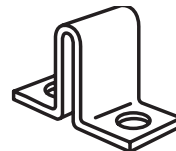

**OJ5**

Closed over barrier for TB200HB  
**OJ5-J** (bulk)

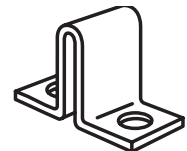

**OJ7**

Closed over barrier for TB200  
**OJ7-J** (bulk)

## TB300 and TB345 double row terminal blocks

### Ratings\*

- Volts 600 V
- Amps
  - 30 A (TB300)
  - 45 A (TB345)
- Breakdown voltage 7500 V
- \* Maximum rating shown; some options may be rated lower.



### Agency information

UL File E62622, CSA File 47235; IEC Compliance

### Specifications

- Poles: 2 to 24
- Wire range: 8 - 22 AWG Cu
- Center spacing: 0.562" or 9/16" (14mm)
- Screw size
  - TB300 — #8-32 phil-slot screws
  - TB345 — #10-32 phil-slot screws
- Torque rating
  - #8 screws - 16 lb-in
  - #10 screws - 20 lb-in
- Distance between barriers: 0.41" (10mm)
- Mounting
  - TB300 — #8 screws
  - TB345 — #10 screws
- Operating temperature: -40°C to 130°C (-40°F to 266°F)

### Materials

- Molded black thermoplastic base, UL rated 94V0
- Tin-plated brass terminals
- Zinc-plated steel screws

### Catalog number build-a-code

Symbol	Screw size	Poles	Screw options	Marking/cover	Hardware options
TB		—			
	<b>300</b> = 8-32 screw	<b>02</b> to <b>24</b>	<b>Blank</b> = Steel phil-slot, zinc-plated	<b>L1</b> to <b>L6</b> marking options, see page 10-16	<b>QC1</b> to <b>QC20</b> = Quick-connects (TB300 only)
	<b>345</b> = 10-32 screw		<b>00</b> = Screws shipped bulk <b>B</b> = Brass phil-slot, nickel-plated <b>BS</b> = Brass SEMS phil-slot, nickel-plated (TB300 only) <b>SP</b> = Steel SEMS phil-slot, zinc-plated <b>ST</b> = Stainless steel, phil-slot	Special markings†, see page 10-16	<b>Custom options (TB300 only)†</b> <b>J301</b> = Flat slip-on jumper <b>OJ6</b> = Over barrier jumper <b>OJ11</b> = Over barrier jumper

† Contact factory for configuration.

### Accessories

- Marker strips, see page 10-17
- Covers, see page 10-16

## Dimensions — in

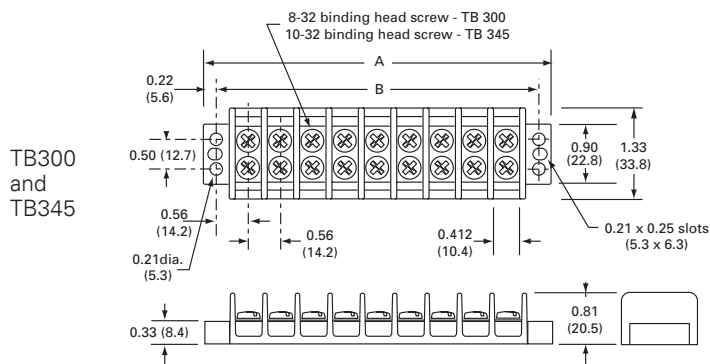

Poles	A	B	Poles	A	B	Poles	A	B
02	2.13	1.69	10	6.62	6.19	18	11.12	10.68
03	2.69	2.25	11	7.18	6.75	19	11.68	11.25
04	3.25	2.81	12	7.75	7.31	20	12.24	11.81
05	3.81	3.37	13	8.31	7.87	21	12.80	12.37
06	4.37	3.94	14	8.87	8.44	22	13.37	12.93
07	4.94	4.50	15	9.43	9.00	23	13.93	13.50
08	5.50	5.06	16	9.99	9.56	24	14.49	14.06
09	6.06	5.62	17	10.56	10.12			

1" = 25.4mm.

**Screw options**



**B**  
Brass phil-slot nickel-plated  
- **B001-7018-J** (TB300 bulk)  
- **B500-023-028-J** (TB345 bulk)



**BS**  
Brass SEMS phil-slot nickel-plated  
- **B001-7015-J** (TB300 bulk)



**SP**  
Steel SEMS phil-slot zinc-plated  
- **B001-7017-J** (TB300 bulk)  
- **B001-5774-J** (TB346 bulk)



**ST**  
Stainless steel phil-slot  
- **B001-7063-J** (TB300 bulk)  
- **B001-7064-J** (TB345 bulk)

**Hardware options**

Quick-connects — assembled: TB300 only; 0.25" x 0.031" terminals, 20 amps maximum. For other orientations, contact factory.

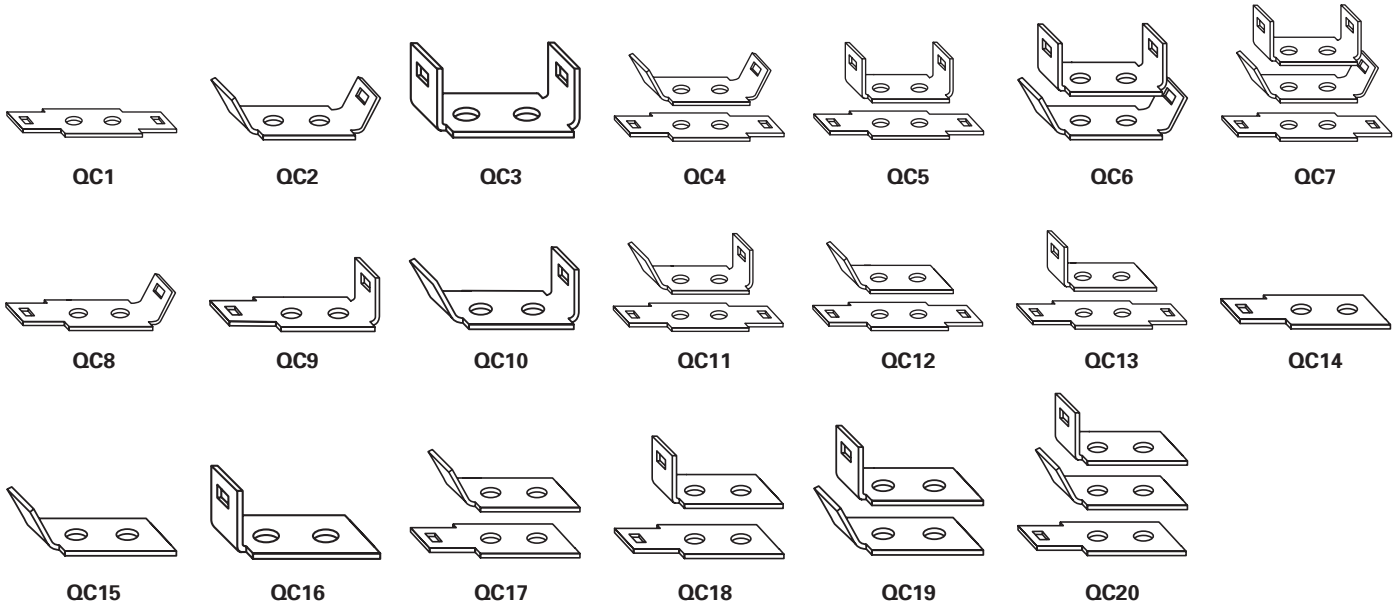

Quick-connects — bulk: \*TB300 only; minimum order 100 pieces per catalog number.

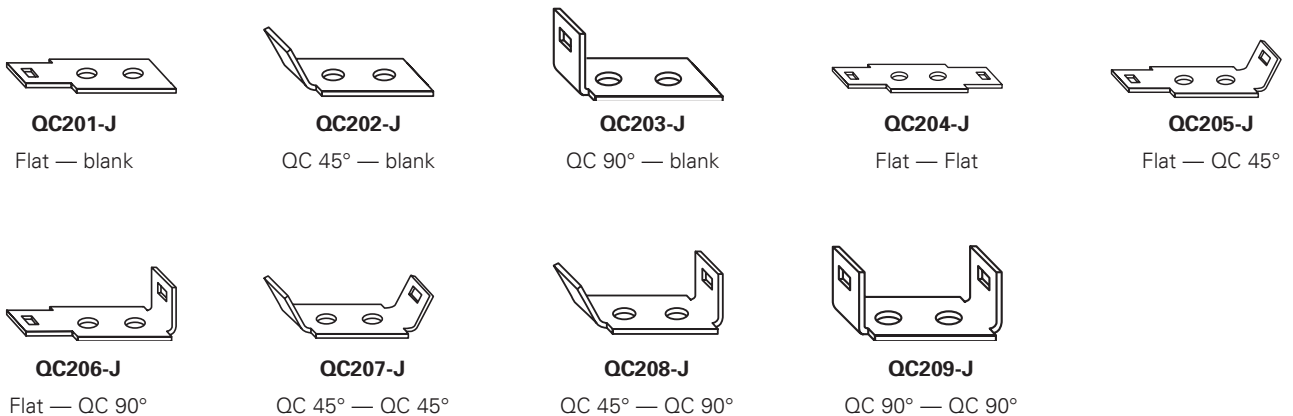

Jumpers — bulk: TB300 only; minimum order 100 pieces per catalog number. Contact factory for jumper assembly.

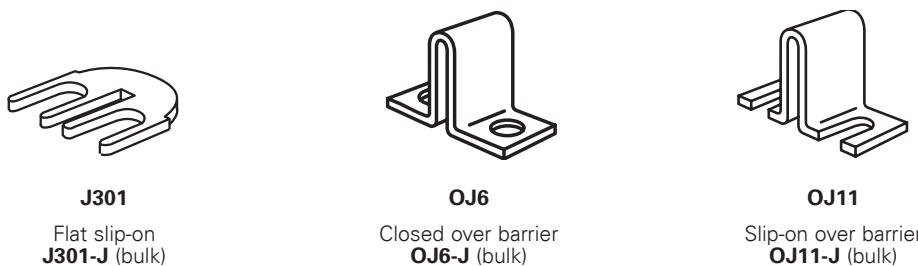

**Marking options and covers for double row terminal blocks**

**Standard marking**

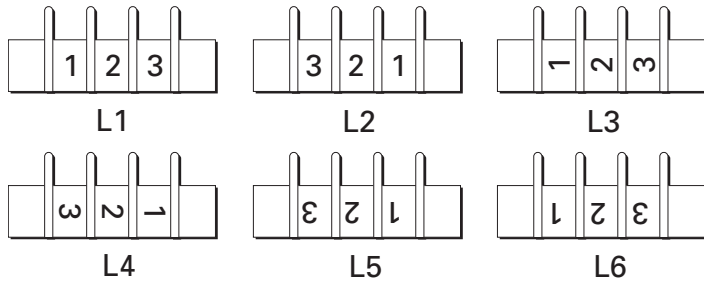

Standard markings are applied directly to the side(s) of a block. The standard marking color is white. The standard numeral height is 0.125 inches (3mm).

Note: Blocks marked on both sides require a different code for each side. Example: Style L1 on one side of the block requires Style L2 on the other side to ensure common terminal marking. To order, add appropriate suffix (L1, L2, L3, L4, L5 and/or L6) to block catalog number in the proper sequence.

**Special marking\***

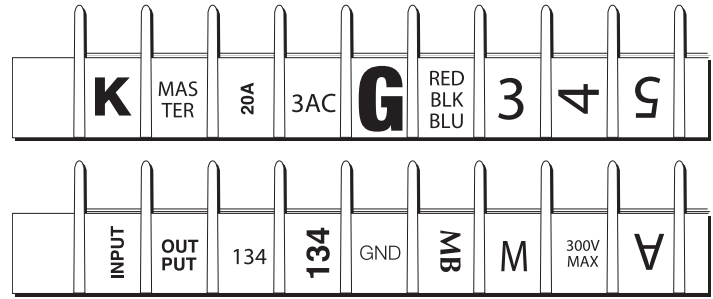

Special markings are available at an additional charge. Drawing(s) must be submitted to ensure accuracy of part required. Consult factory for price and delivery.

\* Not available on TB400 products

**Covers**

**(must be ordered separately)**

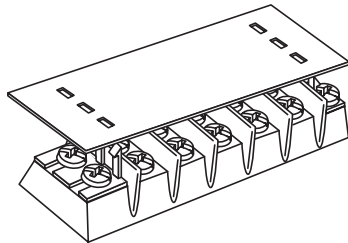

Covers prevent personnel, screws and foreign items from contacting live terminals, and are available in white (opaque) or clear plastic. Two cover clips are supplied with each cover. The cover width is 1.31 inches (33mm). Example: 10 position cover, white, TB100 = catalog number X12010.

**Cover catalog number build-a-code†**

Symbol	Cover strip†	Poles	High barrier option only
X			
	119 = TB100 - clear	02 to 36 (TB100)	HB = High barrier††
	120 = TB100 - white	02 to 30 (TB200/TB200HB)	
	219 = TB200/TB200HB - clear	02 to 24 (TB300/TB345)	
	220 = TB200/TB200HB - white		
	319 = TB300/TB345 - clear		
	320 = TB300/TB345 - white		

† Cover strip not available for TB400 products.

††Applicable to X219 and X220 only.

Catalog no.	For block family
DD1-J	TB100
DD2-J	TB200
DD2HB-J	TB200HB
DD3-J	TB300

**Cover clips — bulk**



**Top marker strips**  
(order separately from blocks)

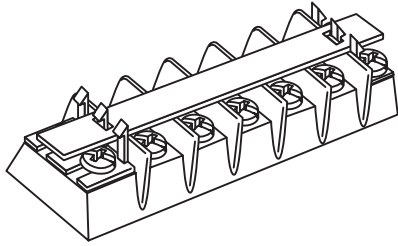

Top mounting marker strips must be ordered separately and are only available in white (opaque) plastic. Two cover clips are supplied with each marker strip.

Example: 12 position cover, TB200, 0.032" x 0.312" = catalog number X20312.

Example: 12 position cover, TB200HB, 0.06" x 0.50" = catalog number X23312HB.

**Top marker strip catalog number build-a-code**

Series	Top marker strip†	Poles	High barrier option only
X			
	<b>103</b> = TB100 (0.032 thk x 0.312 w)	<b>02 to 36</b> (TB100)	<b>HB</b> = High barrier††
	<b>133</b> = TB100 (0.060 thk x 0.500 w)	<b>02 to 30</b> (TB200/TB200HB)	
	<b>203</b> = TB200/TB200HB (0.032 thk x 0.312 w)	<b>02 to 24</b> (TB300/TB345)	
	<b>233</b> = TB200/TB200HB (0.060 thk x 0.500 w)		
	<b>303</b> = TB300/TB345 (0.032 thk x 0.380 w)		
	<b>333</b> = TB300/TB345 (0.060 thk x 0.500 w)		

† Marking strips not available for TB400 products  
††Applicable to X203 and X233 only.

**Bottom marker strips**  
(order separately from blocks)

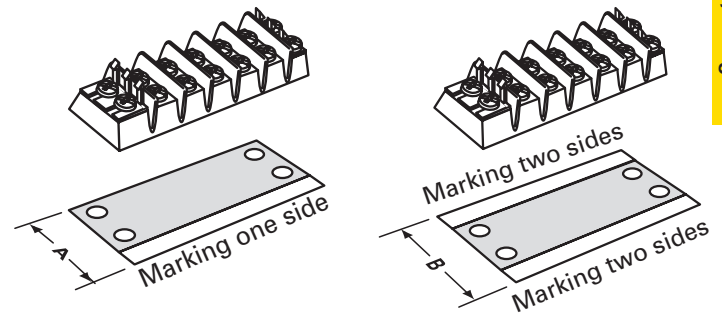

Bottom mounting marker strips are made of 0.03" thick black PVC. Space is available along the edge to handle most marking needs. All marker strips must be ordered separately.

To order, specify catalog number and required marking orientation. Example: 13 position strip, TB100 with no markings, space for marking one side = catalog number X10513. Consult factory for specials.

Standard numeral height is 0.125". Standard markings are 0-99. Special markings are available on special order. Drawing(s) must be submitted to ensure accuracy of part required.

**Dimensions — in**

Dim.	For TB block					
	TB100	TB200	TB200HB	TB300	TB345	TB400
A	1.13	1.37	1.62	1.58	1.58	N/A
B	1.38	1.62	1.81	1.81	1.81	N/A

**Bottom marker strip catalog number build-a-code**

Symbol	Bottom Marker Strip†	Poles	Marking orientation
X			
	<b>101</b> = TB100 marking both sides	<b>02 to 36</b> (TB100)	<b>BF</b> = Bottom forward
	<b>105</b> = TB100 marking one side	<b>02 to 30</b> (TB200/TB200HB)	<b>BR</b> = Bottom reverse
	<b>201</b> = TB200 marking both sides	<b>02 to 24</b> (TB300/TB345)	<b>TF</b> = Top forward
	<b>205</b> = TB200 marking one side		<b>TR</b> = Top reverse
	<b>291</b> = TB200HB marking both sides		
	<b>295</b> = TB200HB marking one side		
	<b>301</b> = TB300 and TB345 marking both sides		
	<b>305</b> = TB300 and TB345 marking one side		

† Not available for TB400 products.

## TB400 double row terminal blocks

### Ratings

- Volts 600 V
- Amps 75 A
- Breakdown voltage 7500 V



TB400-05

### Agency information

- UL File E62622, CSA File 47235; IEC Compliance

### Specifications

- Poles: 2 to 12
- Wire range: 6-14 AWG Cu
- Center spacing: 0.687" or 11/16" (17mm)
- Distance between barriers: 0.56" (14mm)
- Screw size: #10-32 phil-slot screws
- Torque rating: 20 lb-in
- Mounting: #10 screws
- Operating temperature: -40°C to 130°C (-40°F to 266°F)

### Materials

- Molded black thermoplastic base, UL rated 94V0
- Tin-plated brass terminals
- Zinc-plated steel screws

### Dimensions — in

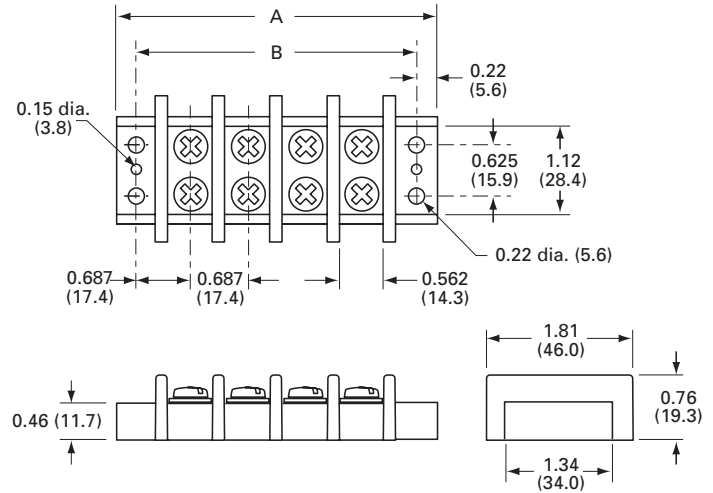

Poles	A	B	Poles	A	B	Poles	A	B
02	2.51	2.06	06	5.26	4.81	10	8.01	7.56
03	3.20	2.75	07	5.95	5.50	11	8.70	8.25
04	3.89	3.44	08	6.64	6.19	12	9.39	8.94
05	4.58	4.13	09	7.33	6.88			

1" = 25.4mm.

### Screw options



Brass nickel-plated phil-slot  
**B500-023-028-J** (bulk)



Stainless steel phil-slot  
**B001-7064-J** (bulk)

### Hardware options

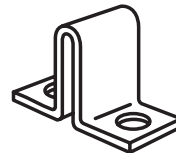

**OJ14**: Closed over barrier  
**OJ14-J** (bulk)

### Catalog number build-a-code

Symbol	Poles	Screw options
TB400	—	

- 02 to 12** Blank = Zinc-plated steel phil-slot  
**00** = Screws shipped bulk  
**B** = Nickel-plated brass phil-slot  
**ST** = Stainless steel, phil-slot

### Accessories

- **OJ14** - Jumper over barrier, consult factory for pole configuration

**KU double row terminal blocks**

**Ratings**

- Volts 600 V
- Amps 60 A\*
- \* 60 A rating achieved with 6 AWG Cu wire crimped to ring terminal.

**Agency information**

- UL File E62622, CSA File 47235

**Specifications**

- Poles: 2 to 12
- Wire range: 6-22 AWG Cu
- Center spacing: 0.625" (16mm)
- Screw size: #10-32
- Torque rating: 20 lb-in
- Distance between barriers: 0.437" (11mm)
- Mounting: Panel mount
- Operating temperature: 105°C (221°F) max.

**Materials**

- Molded black Noryl base, UL rated 94V1
- Terminal plating: Nickel-plated brass terminals
- Zinc-plated steel screws

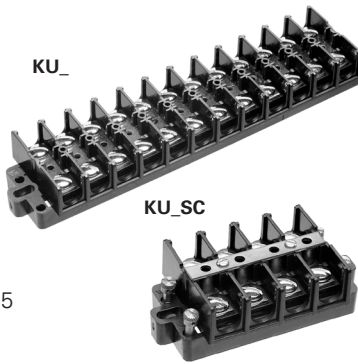

**Dimensions — in**

Poles	KU		KUX only
	A	B	A
02	2.50	1.62	2.00
04	3.75	2.87	3.25
06	5.00	4.12	4.50
08	6.25	5.37	5.75
10	7.50	6.62	7.00
12	8.75	7.87	8.25

1" = 25.4mm.

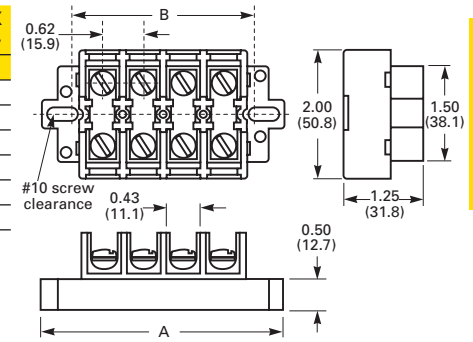

Connector products

**Accessories (order separately)**

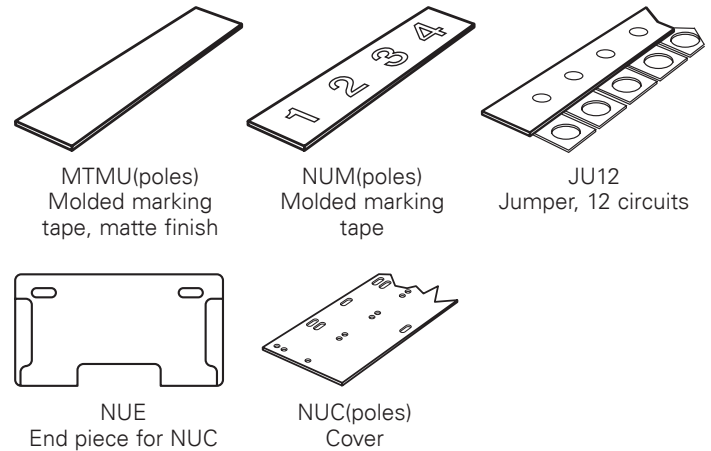

**Catalog number build-a-code - KU versions**

Symbol / for	Poles	Screw options	Covers	Marking strip
KU / Standard block	2 4	00 = Screws shipped bulk	WC = Top cover and 2 end plates	MT = Matte finish
KUX / Short block	6 8 10 12	BP = Brass phil-slot, nickel-plated		NU = Numbered 1 to 12, horizontal
KURL / Standard w/removable link		P = Steel screw w/pressure plate zinc-plated		NUV = Numbered 1 to 12, vertical
KUXRL / Short block w/removable link		W = Brass washer head, nickel-plated		PT = Marker strip for covert

**Catalog number build-a-code - KU\_SC versions**

Symbol / for	Poles	Screw options	Covers	Marking strip
KUSC / Standard w/shorting strap and 4 shorting screws	2 4	00 = Screws shipped bulk	WC = Top cover and 2 end plates	PT = Marker strip for covert
KUXSC / Short block w/shorting strap and 4 shorting screws	6 8 10 12	BP = Brass phil-slot, nickel-plated		
		P = Steel screw w/pressure plate, zinc-plated		
		W = Brass washer head, nickel-plated		

† Requires WC cover option

**End brackets**

**BRKT-ND**

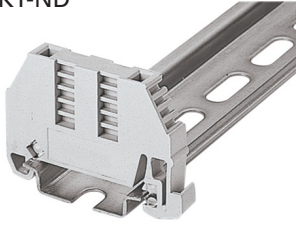

Use with DRL35MMHI  
DRL35MMLO

**BRKT-NDSCRW**

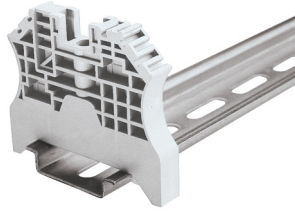

Use with DRL35MMHI  
DRL35MMLO

**BRKT-NDSCRW2**

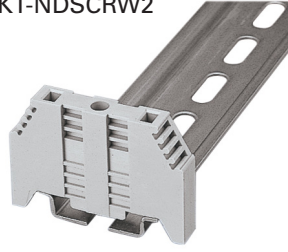

Use with DRL35MMHI  
DRL35MMLO

**BRKT-NDSCRW3**

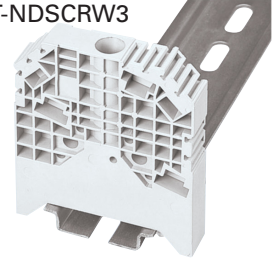

Use with DRL35MMHI  
DRL35MMLO

**Dimensions — mm**

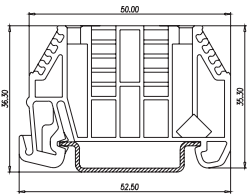

**Dimensions — mm**

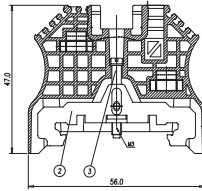

**Dimensions — mm**

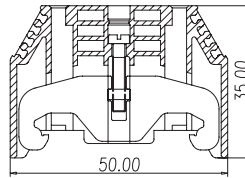

**Dimensions — mm**

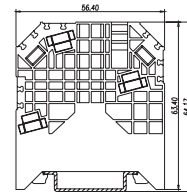

**Mounting rails and brackets**

**DRL35MMLO\***

Low profile  
35mm DIN-Rail



**DRL35MMHI\***

High profile  
35mm DIN-Rail



**NFTA\*\***

C-Rail



**NRA\*\***

C-Rail



**BRKT-ANGL**

Angle bracket



**BRKT-FLT**

Flat bracket



\* Available in 1 meter lengths only.

\*\* Cut-to-length. Consult your Bussmann series product representative for details.