

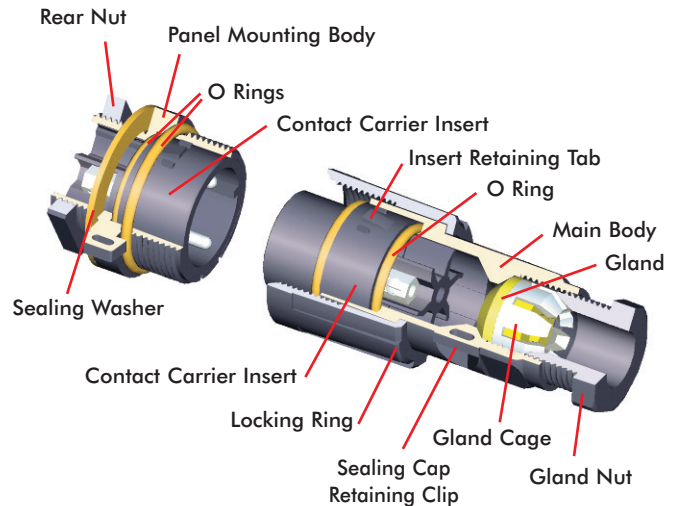

# Mini Buccaneer®

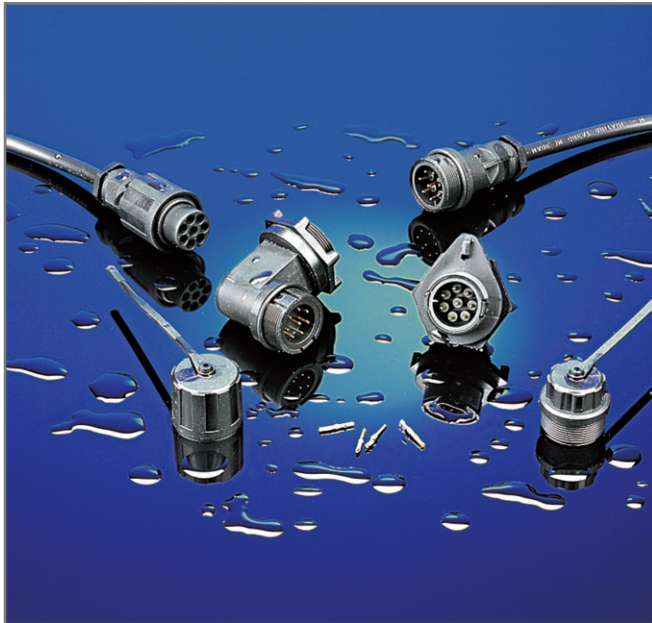

BUCCANEER POWER

- Water and dustproof to IP68 when mated
- IP68 rating tested at 1.054kg/sq cm (15lb/sq in) 10m depth for 2 weeks
- 2, 3, 4 or 6 pole screw terminal inserts
- 3 or 8 pole solder or crimp inserts
- 5 body styles, Flex, Flex In-Line, Panel (2 styles), Panel Side Entry
- 50 | or 75 | BNC inserts
- 5A, 380V a.c. 3 & 8 way solder/crimp terminals
- 10A, 250V a.c. 2 & 3 way screw terminals
- 6A, 250V a.c. 4 way screw terminal
- 3A, 250V a.c. 6 way screw terminal

- Plug or socket connection in each body style
- Cable range from 3.5mm - 9mm
- Diameter over coupling ring 26mm
- Positive locating keyways - cannot be mis-mated
- Sealing caps available to maintain IP68 rating of unmated connectors
- Flammability rating UL94V-0 material
- Leading earth contact on all types (except 2 pole)
- Compact design
- Easy assembly - no special tools required on screw terminal versions
- UL approval

## Mini Buccaneer®

### FLEX CABLE CONNECTOR

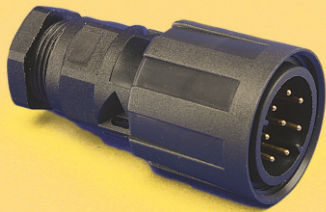

**PX0800 - shown with insert**

- PX0800 Connector body
- Mates with Flex In-line or Panel Mounting versions
- Screw locking ring
- Suitable for Pin or Socket inserts
- Cable Acceptance 3.5-9mm (Standard 5-7mm)
- Contact inserts supplied separately

61.5 Max. Depending on Cable Dia. / Pin or Socket Carrier.

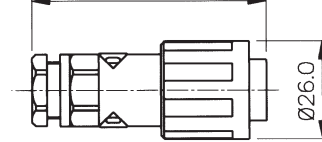

### IN-LINE FLEX CABLE CONNECTOR



**PX0801 - shown with insert**

- PX0801 Connector body
- Mates with PX0800 - Flex Cable connector
- Suitable for Pin or Socket inserts
- Cable Acceptance 3.5-9mm (Standard 5-7mm)
- Contact inserts supplied separately

61.5 Max. Depending on Cable Dia. / Pin or Socket Carrier.

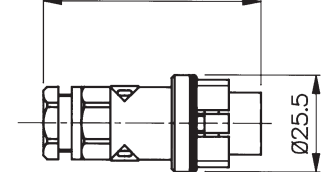

### PANEL MOUNTING



**PX0802 - shown with insert**

- PX0802 Connector body
- Mates with PX0800 - Flex Cable connector
- Single hole fixing
- Suitable for Pin or Socket inserts
- Contact inserts supplied separately

37.0 Max. Depending on Pin or Socket Carrier.

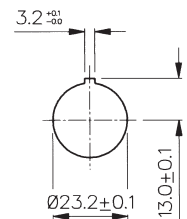
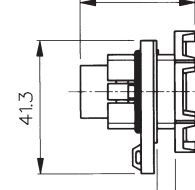

Fixing Details.

### PANEL MOUNTING



**PX0803 - shown with insert**

- PX0803 Connector body
- Mates with PX0800 - Flex Cable connector
- Right angle cable entry
- Single hole fixing
- Suitable for Pin or Socket inserts
- Contact inserts supplied separately

53.4 Max. Depending on Panel Thickness.

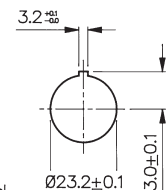
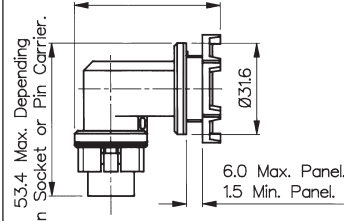

Fixing Details.

### PANEL MOUNTING



**PX0805 - shown with insert**

- PX0804 and PX0805 Connector bodies
- Mates with PX0800 - Flex Cable connector
- PX0804 without sealing cap retaining clip, PX0805 with sealing cap retaining clip
- Single hole fixing
- Suitable for Pin or Socket inserts
- Contact inserts supplied separately

33.6 Max. Depending on Pin or Socket Carrier.

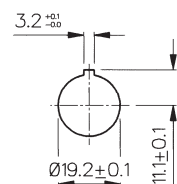
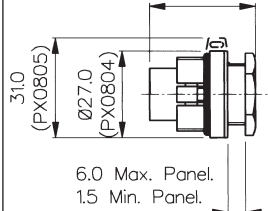

Fixing Details.

### SCREW TERMINAL INSERTS

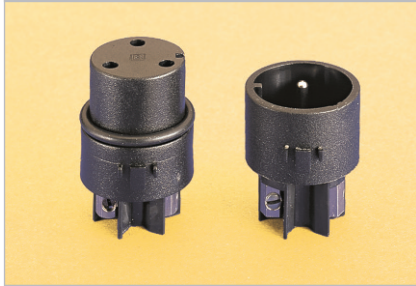

- 2, 3, 4 and 6 Poles
- Fits all Body Styles
- Leading Earth Pin on 3, 4 and 6 pole inserts
- Nickel Plated contacts

### Screw Terminal Inserts - fit all body styles

No. Poles	Socket	Pin
2	SA3319	SA3320
3	SA3229	SA3230
4	SA3242	SA3241
6	SA3244	SA3243

### CONTACT CARRIER INSERTS



Inserts shown with contacts fitted

- For Solder or Crimp Contacts
- 3 or 8 Pin
- Fits all Body Styles
- Contacts Supplied Separately

### Solder & Crimp Contact Carrier Inserts - fit all body styles.

No. Poles	Solder	Colour	Crimp	Colour
8 pin	12734/1	Black	12734	Grey
8 socket	12735/1	Black	12735	Grey
3 pin	12734/3/1	Black	12734/3	Grey
3 socket	12735/3/1	Black	12735/3	Grey

BUCCANEER POWER

### CONTACTS, POLARISING/BLANKING PINS

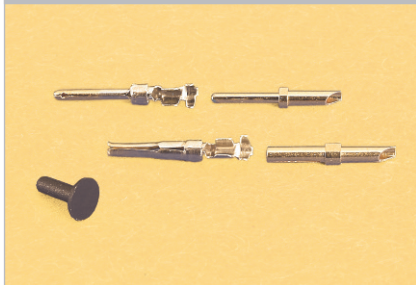

- Gold Plated contacts
- Solder or Crimp
- Polarising/Blanking pins

### Contacts - Solder & Crimp - for contact carrier inserts

Contacts (Supplied in packs of 10)	Solder	Crimp
Pins	SA3148/1	SA3148
Sockets	SA3149/1	SA3149
Polarising/Blanking Pins	SA3147	
Contact Insertion Tool: Must be used to load contacts into inserts.	SA3150	
Crimping Tool	SA2800	

### BNC INSERT KIT



Inserts Shown assembled

- BNC inserts for 50 | and 75 | co-ax cables
- Includes gland and washer to suit coax cable
- Fits all Body Styles (except PX0803)

### BNC Inserts - fit all body styles except PX0803

Imp.	Cable Type	Contacts	Part No.
50	RG58/CU, URM43, URM76	Plug	SA3159/1
50	RG58/CU, URM43, URM76	Socket	SA3157/1
75	URM70	Plug	SA3159
75	URM70	Socket	SA3157

### SEALING CAPS



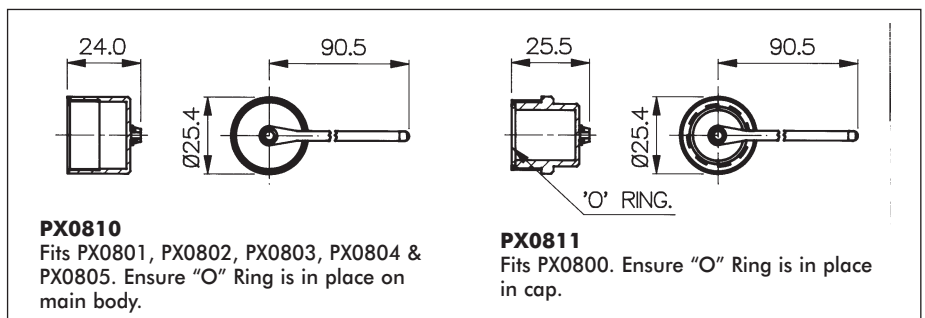

To maintain IP rating



## Mini Buccaneer® Contact Inserts and Accessories

### SPECIFICATION

Electrical	Solder/Crimp Terminals	Screw Terminals	BNC
No Poles:	3, 8	2, 3      4      6	
Current Rating:	5A	10A      6A      3A	
Voltage Rating:	380V ac	250V ac    250V ac    250V ac	
Contact Resistance:	<5m $\Omega$		
Insulation Resistance:	>10 $\Omega$ M   @ 500V d.c.		
Voltage Proof:	2kV @ 50Hz		
Operating Temp. Range:	-20°C to +70°C		
Approvals:	E214972		
			
Materials	Solder/Crimp Terminals	Screw Terminals	BNC
Body Mouldings:	Polyamide UL94V-0	Polyamide UL94V-0	
Inserts:	Polyamide UL94V-0	Polyamide UL94V-0	
Contacts:	Copper Alloy, Gold Plated (0.1 $\mu$ m) on Nickel	Brass, Nickel Plated	Brass, Silver Plated.
O Rings:	Nitrile		
	Compliant	Compliant	Compliant
Mechanical	Solder/Crimp Terminals	Screw Terminals	BNC
Sealing:	Protection Classification IP68, BS EN60529:1992. Tested @ 1.054kg/sq.cm. (15lb/sq.in.) 10m depth for 2 weeks.		
Cable Acceptance	5-7mm dia - standard gland 3.5-9mm dia - alternative glands		
Contact Accommodation:	0.2 - 0.5mm <sup>2</sup> (20 - 24 AWG)	1mm <sup>2</sup> max (18 AWG)	50   : RG58/CU, URM43, URM76 75   : URM70
Insertion Force (typical):	3 way: 5N (1.1lbf) 8 way: 14N (3.1lbf)	3 way: 45N (10lbf) 4 way: 50N (11lbf) 6 way: 140N (31lbf)	
Withdrawal Force (typical):	3 way: 3N (0.66lbf) 8 way: 12N (2.6lbf)	3 way: 32N (7lbf) 4 way: 40N (9lbf) 6 way: 150N (34lbf)	
Tightening Torques			
Gland Nut, PX0800, 801:	1.13Nm (10lbf in)		
Rear Nut, PX0802, 803, 804, 805:	0.7Nm min, 1.7Nm max (6.2lbf in min, 15lbf in max)		
Sealing Cap, PX0810, 811:	0.23Nm min, 1.13Nm max (2lbf in min, 10lbf in max)		

### HOW TO ORDER

- Choose body type, check cable diameter and sealing gland size.
- Determine contact carrier inserts. Choose number of poles, and type of contacts (solder, crimp, screw terminal or BNC).
- Choose pins or sockets. Solder and crimp contacts are supplied separately in packs of ten.
- Choose polarising/blanking pins. If required for solder/crimp contact inserts. Supplied in packs of ten.
- Is an insertion tool required (for solder or crimp contacts)?
- Is a crimp tool required?
- Is a sealing cap required?

### CABLE GLANDS

Cable gland for 5-7mm fitted as standard.  
BNC Insert Kit includes gland & washer to fit coax cable.

Cable Diameter	Gland Part No.	Gland Colour	Additional Suffix
5-7mm	12023/1	White	Fitted as standard
3.5-5mm	SA3426	Grey	Suffix /04†
6-8mm	12023	Black	Suffix /06
7-9mm	12023/2	Yellow	Suffix /07
Gland Pack	PX0812	Pack of 3 glands to suit cables 3.5-5mm, 6-8mm, 7-9mm dia†	

To order body with alternative cable gland add suffix to part no. e.g. PX0800/06 = PX0800 body with cable gland to suit 6-8mm dia. cable.

†Includes additional black gland cage for 3.5-5mm dia. cable range.