

Type 381LX / 383LX 105 °C High Ripple, Snap-In Aluminum

High Ripple, Long Life, 2, 4 and 5 pin styles available



Adding longer-life and more ripple capability to the excellent value of Type 380L/LX capacitors, the 381L/LX readily handles tough switching power supply input and output circuits and motor-drive bus capacitor applications where the high surface area of multiple units in parallel equals the ripple capability of our Type 520C inverter-grade capacitor. Type 381LX delivers more capacitance per can size while Type 381L gives lower ESR for the same capacitance rating. Type 383L/LX has 4 or 5 leads for stable, reverse-proof mounting.

Highlights

- Top performance in power supplies and motor drives
- 4 times the life of Type 380L/LX
- 2, 4 and 5 leads available
- Big selection of 42 case sizes

Specifications

Temperature Range	-40 °C to + 105 °C ≤ 250 Vdc -25 °C to + 105 °C ≥ 315 Vdc																																																								
Rated Voltage Range	10 Vdc to 600 Vdc																																																								
Capacitance Range	33 µF to 150,000 µF																																																								
Capacitance Tolerance	± 20%																																																								
Leakage Current	≤ 3 \sqrt{CV} µA, 4 mA max, 5 minutes																																																								
Ripple Current Multipliers	<p>Ambient Temperature</p> <table border="1"> <thead> <tr> <th colspan="2"></th> <th>45 °C</th> <th>60 °C</th> <th>70 °C</th> <th>85 °C</th> <th>105 °C</th> </tr> </thead> <tbody> <tr> <td>381L, 383L</td> <td>0-450 Vdc</td> <td>2.70</td> <td>2.60</td> <td>2.50</td> <td>2.10</td> <td>1.00</td> </tr> <tr> <td>381LX, 383LX</td> <td>0-450Vdc</td> <td>2.35</td> <td>2.20</td> <td>2.00</td> <td>1.70</td> <td>1.00</td> </tr> <tr> <td>381LX, 383LX</td> <td>500-600 Vdc</td> <td>1.90</td> <td>1.90</td> <td>1.80</td> <td>1.70</td> <td>1.00</td> </tr> </tbody> </table> <p>Frequency</p> <table border="1"> <thead> <tr> <th></th> <th>50Hz</th> <th>60Hz</th> <th>120Hz</th> <th>500Hz</th> <th>1KHz</th> <th>10KHz</th> </tr> </thead> <tbody> <tr> <td>10-100vdc</td> <td>0.93</td> <td>0.95</td> <td>1.00</td> <td>1.05</td> <td>1.08</td> <td>1.15</td> </tr> <tr> <td>160-450Vdc</td> <td>0.75</td> <td>0.80</td> <td>1.00</td> <td>1.20</td> <td>1.25</td> <td>1.40</td> </tr> <tr> <td>500-600Vdc</td> <td>0.70</td> <td>0.75</td> <td>1.00</td> <td>1.20</td> <td>1.25</td> <td>1.30</td> </tr> </tbody> </table>			45 °C	60 °C	70 °C	85 °C	105 °C	381L, 383L	0-450 Vdc	2.70	2.60	2.50	2.10	1.00	381LX, 383LX	0-450Vdc	2.35	2.20	2.00	1.70	1.00	381LX, 383LX	500-600 Vdc	1.90	1.90	1.80	1.70	1.00		50Hz	60Hz	120Hz	500Hz	1KHz	10KHz	10-100vdc	0.93	0.95	1.00	1.05	1.08	1.15	160-450Vdc	0.75	0.80	1.00	1.20	1.25	1.40	500-600Vdc	0.70	0.75	1.00	1.20	1.25	1.30
		45 °C	60 °C	70 °C	85 °C	105 °C																																																			
381L, 383L	0-450 Vdc	2.70	2.60	2.50	2.10	1.00																																																			
381LX, 383LX	0-450Vdc	2.35	2.20	2.00	1.70	1.00																																																			
381LX, 383LX	500-600 Vdc	1.90	1.90	1.80	1.70	1.00																																																			
	50Hz	60Hz	120Hz	500Hz	1KHz	10KHz																																																			
10-100vdc	0.93	0.95	1.00	1.05	1.08	1.15																																																			
160-450Vdc	0.75	0.80	1.00	1.20	1.25	1.40																																																			
500-600Vdc	0.70	0.75	1.00	1.20	1.25	1.30																																																			
Low Temperature Characteristics	Impedance ratio: $Z_{-20^{\circ}\text{C}}/Z_{+25^{\circ}\text{C}}$ @120Hz ≤ 10 (10 Vdc) ≤ 8 (16-50 Vdc) ≤ 4 (63-100 Vdc) ≤ 3 (150-450 Vdc)																																																								
Endurance Life Test	3000 h at full load at 105 °C Δ Capacitance ±20% ESR 200% of limit DCL 100% of limit																																																								
Shelf Life Test	<p>0 - 500 Vdc</p> <p>1,000 h @ 105 °C Δ Capacitance ±20% ESR 200% of limit DCL 100% of limit</p> <p>501 - 600 Vdc</p> <p>500 h @ 105 °C Δ Capacitance ±20% ESR 200% of limit DCL 100% of limit</p>																																																								
Vibration	10 to 55 Hz, 0.06" and 10 g max, 2 h each plane																																																								

Regulatory Information

Type 381LX / 383LX 105 °C High Ripple, Snap-In Aluminum

High Ripple, Long Life, 2,4 and 5 pin styles available

383LX	272	M	200	N08	2	V
Type	Cap	Tolerance	Voltage	Case Code	Insulation	# of pins
381L / LX (2 pins)	100 = 10 µF	M = ±20%	200 = 200 Vdc		2 = PVC	Blank = 2 pins / 4 pins snap-in 6.3mm L
383L / LX (4 or 5 pins)	101 = 100 µF				or PET (PET after 12/19)	A = 2 pins / 4 pins snap-in 4.0mm L
	272 = 2700 µF					VS = 5 pins snap-in 6.3mm L
						V = 5 pins standoff

Outline Drawings

Dimensions shown are in mm

Sleeving is PVC or PET (PET for all date codes after December 2019)

Two Pins

381L/LX (22 through 40 mm diameter)

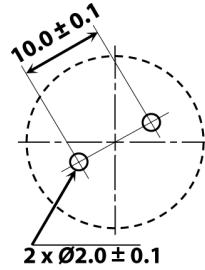
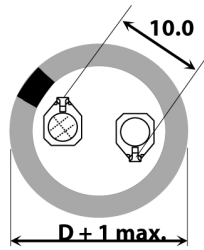
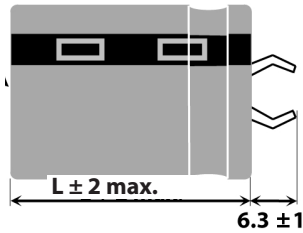

PC Board Mounting Holes

Available in 2, 4 and 5 pins

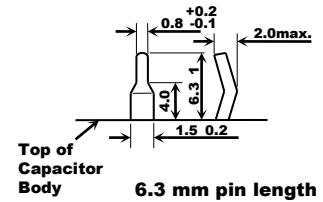

Four Pins

383L/LX (35 and 40 mm diameter)

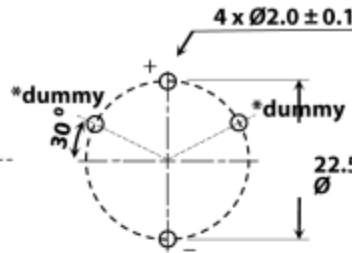
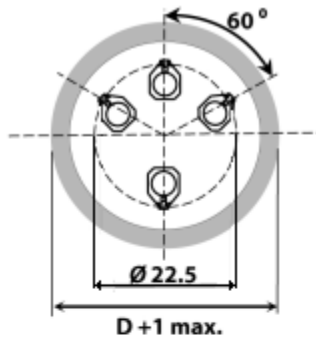
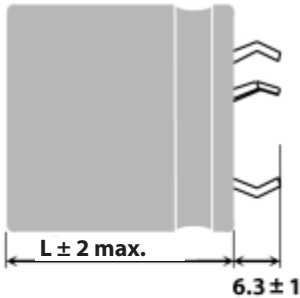

PC Board Mounting Holes

Available in 2 and 4 pins

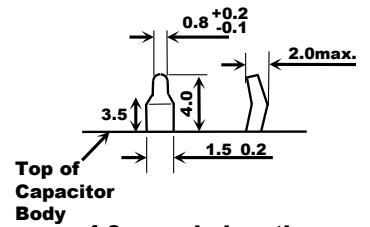

4.0 mm pin length option (add "A" to end of part#)

Five Pins

383L/LX (40 and 50 mm diameter)

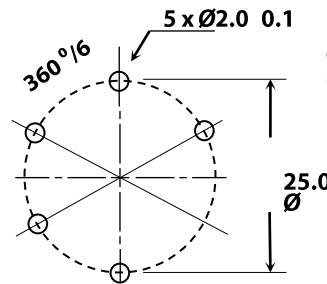
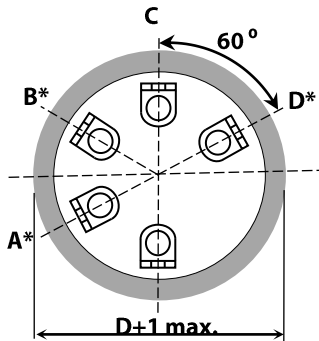
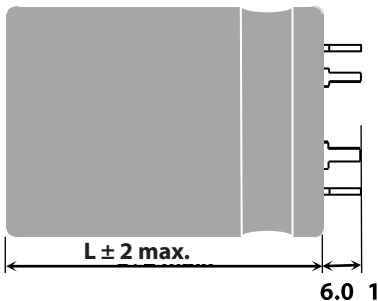

PC Board Mounting Holes

Available in 5 pins

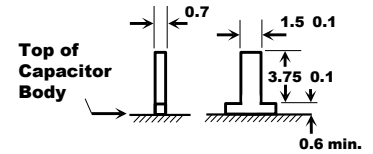

5 pin Standoff pin style (add "V" to end of part#)

Terminal	Connection	
	40 mm Dia.	50 mm Dia.
A	dummy	negative (-)
B	dummy	dummy
C	positive (+)	positive (+)
D	dummy	positive (+)
-	negative (-)	negative (-)

Notes:

* Use dummy terminals for mechanical support only. Make no electrical connection because they resistively connect through the electrolyte to the negative terminal.

** Safety Vent may be on the bottom or on the side of the can.

Type 381LX / 383LX 105 °C High Ripple, Snap-In Aluminum

High Ripple, Long Life, 2,4 and 5 pin styles available

Insulated Case Dimensions

Case Code	DIAMETER "D"		LENGTH "L"		Typical Weight (grams)
	mm	inches	mm	inches	
H20	22	0.87	20	0.79	14
H01	22	0.87	25	0.98	16
H02	22	0.87	30	1.18	19
H03	22	0.87	35	1.38	22
H04	22	0.87	40	1.57	24
H45	22	0.87	45	1.77	28
H05	22	0.87	50	1.97	31
J20	25	0.98	20	0.79	16
J01	25	0.98	25	0.98	20
J02	25	0.98	30	1.18	24
J03	25	0.98	35	1.38	27
J04	25	0.98	40	1.57	31
J45	25	0.98	45	1.77	35
J05	25	0.98	50	1.97	38
K20	30	1.18	20	0.79	25
K01	30	1.18	25	0.98	30
K02	30	1.18	30	1.18	35
K03	30	1.18	35	1.38	40
K04	30	1.18	40	1.57	44
K45	30	1.18	45	1.77	48
K05	30	1.18	50	1.97	53
A20	35	1.38	20	0.79	35
A01	35	1.38	25	0.98	42
A02	35	1.38	30	1.18	48
A03	35	1.38	35	1.38	54

Case Code	DIAMETER "D"		LENGTH "L"		Typical Weight (grams)
	mm	inches	mm	inches	
A04	35	1.38	40	1.57	62
A45	35	1.38	45	1.77	67
A05	35	1.38	50	1.97	74
A55	35	1.38	55	2.17	80
A06	35	1.38	63	2.48	88
A07	35	1.38	70	2.76	98
A08	35	1.38	80	3.15	112
A10	35	1.38	105	4.13	144
N04	40	1.57	40	1.57	82
N05	40	1.57	50	1.97	105
N06	40	1.57	63	2.48	130
N08	40	1.57	80	3.15	185
N10	40	1.57	105	4.13	265
B05	50	1.97	50	1.97	136
B06	50	1.97	63	2.48	168
B08	50	1.97	80	3.15	239
B09	50	1.97	92	3.62	241
B10	50	1.97	105	4.13	325

Typical Performance Curves

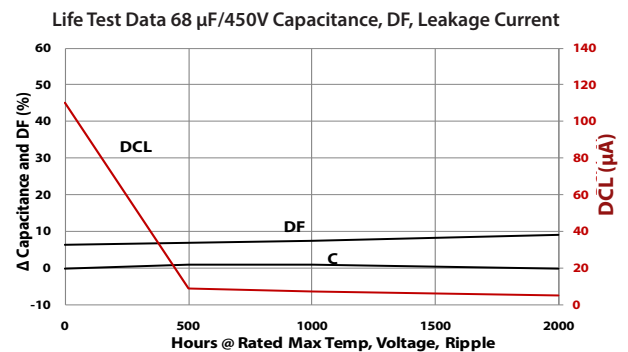
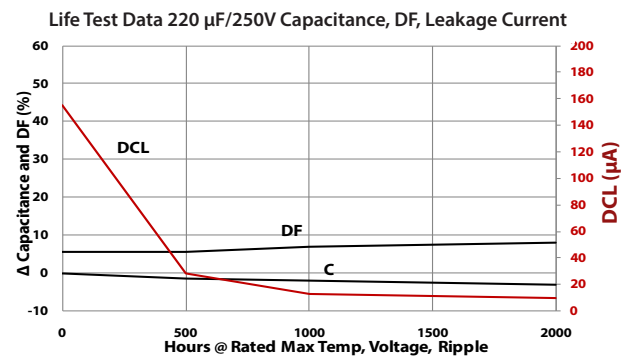
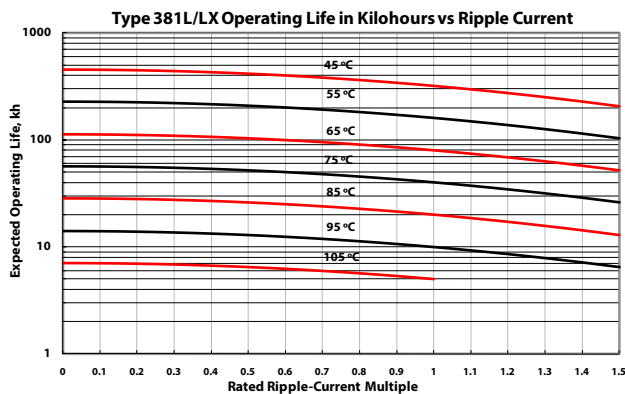

Type 381LX / 383LX 105 °C High Ripple, Snap-In Aluminum

High Ripple, Long Life, 2,4 and 5 pin styles available

Ratings

Cap. (µF)	Catalog Part Number	Max. ESR @ +25°C		Ripple Amps @ +105°C		Nominal Size D x L (mm)	Cap. (µF)	Catalog Part Number	Max. ESR @ +25°C		Ripple Amps @ +105°C		Nominal Size D x L (mm)
		120 Hz (ohms)	20 kHz (ohms)	120 Hz (A)	20 kHz (A)				120 Hz (ohms)	20 kHz (ohms)	120 Hz (A)	20 kHz (A)	
10 Vdc (13 Vdc Surge)							16 Vdc (20 Vdc Surge)						
4700	381LX472M010H012	0.159	0.135	0.85	0.98	22 x 25	47000	383LX473M016N042	0.020	0.018	5.50	6.33	40 x 40
6800	381LX682M010H012	0.111	0.093	1.30	1.50	22 x 25	56000	381LX563M016A452	0.020	0.018	6.00	6.90	35 x 45
10000	381LX103M010H012	0.075	0.063	1.80	2.10	22 x 25	68000	381LX683M016A452	0.020	0.018	6.50	7.50	35 x 45
12000	381LX123M010H012	0.076	0.065	2.20	2.63	22 x 25	68000	383LX683M016N052	0.015	0.014	7.30	8.40	40 x 50
15000	381LX153M010H012	0.076	0.065	2.20	2.53	22 x 25	82000	383LX823M016N062	0.017	0.013	7.70	8.80	40 x 63
18000	381LX183M010H022	0.051	0.043	2.40	2.76	22 x 30	100000	381LX104M016A082	0.015	0.013	8.00	9.20	35 x 80
22000	381LX223M010H032	0.041	0.035	2.60	2.99	22 x 35	120000	381LX124M016A082	0.015	0.013	8.50	9.50	35 x 80
27000	381LX273M010J032	0.034	0.029	3.10	3.57	25 x 35	120000	383LX124M016N082	0.014	0.012	8.80	10.10	40 x 80
33000	381LX333M010J042	0.028	0.023	3.40	3.91	25 x 40	120000	383LX124M016B052V	0.015	0.014	9.02	10.37	50 x 50
39000	381LX393M010K032	0.026	0.023	3.70	4.26	30 x 35	150000	383LX154M016N102	0.013	0.012	9.88	11.36	40 x 105
39000	381LX393M010A022	0.025	0.020	3.70	4.30	35 x 30	150000	383LX154M016B062V	0.014	0.013	10.15	11.67	50 x 63
47000	381LX473M010K032	0.024	0.022	4.20	4.83	30 x 35	180000	383LX184M016B082V	0.013	0.012	11.02	12.67	50 x 80
56000	381LX563M010K042	0.023	0.021	5.00	5.75	30 x 40	220000	383LX224M016B092V	0.012	0.011	11.71	13.47	50 x 92
68000	381LX683M010K452	0.022	0.019	5.40	6.21	30 x 45	250000	383LX254M016B102V	0.011	0.010	12.31	14.16	50 x 105
68000	383LX683M010N042	0.023	0.022	5.40	6.20	40 x 40	25 Vdc (32 Vdc Surge)						
82000	383LX823M010N052	0.018	0.017	7.40	8.50	40 x 50	2200	381LX222M025H202	0.240	0.180	1.30	1.50	22 x 20
120000	383L124M010N062	0.012	0.008	7.10	8.60	40 x 63	3300	381LX332M025H012	0.160	0.120	1.60	1.80	22 x 25
150000	383L154M010N082	0.009	0.006	8.90	10.60	40 x 80	4700	381LX472M025H012	0.105	0.080	2.00	2.30	22 x 25
16 Vdc (20 Vdc Surge)							5600	381LX562M025H012	0.090	0.070	2.20	2.50	22 x 25
3300	381LX332M016H012	0.213	0.170	1.30	1.50	22 x 25	6800	381LX682M025H022	0.085	0.064	2.40	2.76	22 x 30
4700	381LX472M016H012	0.150	0.120	1.60	1.80	22 x 25	6800	381LX682M025J012	0.070	0.055	2.40	2.80	25 x 25
6800	381LX682M016H012	0.090	0.067	2.20	2.50	22 x 25	8200	381LX822M025H022	0.071	0.053	2.70	3.11	22 x 30
6800	381LX682M016J202	0.110	0.092	1.80	2.10	25 x 20	10000	381LX103M025J022	0.058	0.044	3.00	3.45	25 x 30
8200	381LX822M016H012	0.110	0.092	1.80	2.10	22 x 25	12000	381LX123M025J022	0.048	0.036	3.20	3.68	25 x 30
10000	381LX103M016H012	0.075	0.063	2.60	2.99	22 x 25	12000	381LX123M025A012	0.044	0.033	3.20	3.70	35 x 25
10000	381LX103M016J012	0.120	0.086	2.60	3.00	25 x 25	15000	381LX153M025J032	0.039	0.029	3.60	4.14	25 x 35
12000	381LX123M016H022	0.062	0.053	2.90	3.34	22 x 30	15000	381LX153M025J452	0.036	0.031	3.60	4.10	25 x 45
15000	381LX153M016J022	0.046	0.307	3.20	3.70	25 x 30	15000	381LX153M025A022	0.036	0.031	3.60	4.10	35 x 30
15000	381LX153M016J032	0.080	0.064	3.20	3.70	25 x 35	18000	381LX183M025J042	0.032	0.024	3.90	4.49	25 x 40
15000	381LX153M016K022	0.080	0.064	3.20	3.70	30 x 30	18000	381LX183M025J052	0.030	0.027	3.90	4.50	25 x 50
18000	381LX183M016H032	0.041	0.035	3.50	4.03	22 x 35	22000	381LX223M025J452	0.026	0.020	4.30	4.95	25 x 45
22000	381LX223M016H042	0.034	0.029	3.80	4.37	22 x 40	22000	381LX223M025K452	0.025	0.022	4.30	4.90	30 x 45
22000	381LX223M016J452	0.033	0.028	3.80	4.40	25 x 45	22000	381LX223M025A032	0.030	0.026	4.30	4.90	35 x 35
27000	381LX273M016H052	0.028	0.023	4.20	4.83	22 x 50	27000	381LX273M025K042	0.021	0.019	4.80	5.50	30 x 40
27000	381LX273M016J052	0.030	0.025	4.20	4.80	25 x 50	27000	383L273M025N042	0.020	0.013	4.60	5.60	40 x 40
27000	381LX273M016K022	0.028	0.023	4.20	4.83	30 x 30	33000	381LX333M025K452	0.018	0.014	5.50	6.33	30 x 45
33000	381LX333M016K032	0.023	0.020	4.70	5.41	30 x 35	33000	383LX333M025N042	0.018	0.016	5.50	6.33	40 x 40
33000	381LX333M016K452	0.023	0.020	4.70	5.40	30 x 45	39000	383L393M025N052	0.015	0.010	5.80	7.00	40 x 50
39000	381LX393M016K042	0.022	0.020	5.10	5.87	30 x 40	47000	381LX473M025A052	0.017	0.015	6.50	4.25	35 x 50
47000	381LX473M016K452	0.021	0.019	5.50	6.33	30 x 45	47000	383LX473M025N052	0.015	0.014	6.50	7.40	40 x 50
47000	381LX473M016A452	0.020	0.018	5.50	6.30	35 x 45	47000	383L473M025N062	0.012	0.008	6.90	8.30	40 x 63
							56000	383LX563M025N062	0.015	0.012	7.20	8.25	40 x 63

Type 381LX / 383LX 105 °C High Ripple, Snap-In Aluminum

High Ripple, Long Life, 2,4 and 5 pin styles available

Cap. (µF)	Catalog Part Number	Max. ESR @ +25°C		Ripple Amps @ +105°C		Nominal Size
		120 Hz (ohms)	20 kHz (ohms)	120 Hz (A)	20 kHz (A)	
		D x L (mm)				
25 Vdc (32 Vdc Surge)						
68000	383L683M025N082	0.009	0.007	8.70	10.20	40 x 80
82000	383LX823M025N082	0.014	0.011	8.70	10.00	40 x 80
82000	383LX823M025B052V	0.016	0.015	9.20	10.58	50 x 50
100000	383LX104M025N102	0.012	0.010	9.76	11.22	40 x 105
100000	383LX104M025B062V	0.015	0.013	10.02	11.52	50 x 63
120000	383LX124M025B082V	0.013	0.012	10.93	12.57	50 x 80
150000	383LX154M025B092V	0.012	0.011	11.70	13.46	50 x 92
180000	383LX184M025B102V	0.010	0.009	12.42	14.28	50 x 105
35 Vdc (44 Vdc Surge)						
1500	381LX152M035H012	0.287	0.216	1.10	1.30	22 x 25
2200	381LX222M035H012	0.200	0.150	1.40	1.60	22 x 25
3300	381LX332M035H012	0.121	0.091	1.90	2.20	22 x 25
3300	381LX332M035K202	0.130	0.100	1.70	2.00	30 x 20
3900	381LX392M035H012	0.110	0.080	2.00	2.30	22 x 25
4700	381LX472M035H022	0.090	0.070	2.20	2.50	22 x 30
4700	381LX472M035J012	0.090	0.070	2.20	2.50	25 x 25
5600	381LX562M035H032	0.071	0.054	2.40	2.80	22 x 35
5600	381LX562M035J012	0.041	0.054	2.40	2.80	25 x 25
6800	381LX682M035J022	0.073	0.055	2.60	2.99	25 x 30
6800	381LX682M035K022	0.059	0.045	2.60	3.00	30 x 30
8200	381LX822M035J022	0.049	0.037	2.90	3.30	25 x 30
8200	381LX822M035A012	0.049	0.037	2.90	3.30	35 x 25
10000	381LX103M035J032	0.050	0.037	3.20	3.68	25 x 35
10000	381LX103M035J452	0.040	0.030	3.20	3.70	25 x 45
10000	381LX103M035A022	0.040	0.030	3.20	3.70	35 x 30
12000	381LX123M035J042	0.041	0.031	3.50	4.03	25 x 40
12000	381LX123M035J052	0.033	0.025	3.50	4.00	25 x 50
12000	381LX123M035A022	0.033	0.025	3.50	4.00	35 x 30
15000	381LX153M035K042	0.033	0.025	3.90	4.49	30 x 40
15000	381LX153M035K452	0.030	0.020	3.90	4.50	30 x 45
15000	381LX153M035A032	0.030	0.020	3.90	4.50	35 x 35
18000	381LX183M035K452	0.028	0.021	4.30	4.95	30 x 45
22000	381LX223M035A052	0.023	0.017	5.00	5.80	35 x 50
22000	383LX223M035N042	0.023	0.017	5.00	5.75	40 x 40
27000	381LX273M035A052	0.018	0.014	5.30	6.10	35 x 50
27000	383LX273M035N052	0.020	0.015	5.45	6.25	40 x 50
33000	383L333M035N062	0.019	0.014	6.60	7.60	40 x 63
39000	381LX393M035A052	0.017	0.014	6.50	7.50	35 x 50
47000	383L473M035N082	0.018	0.013	7.80	9.00	40 x 80
47000	383LX473M035B052V	0.021	0.016	8.25	9.49	50 x 50
56000	383LX563M035B062V	0.019	0.014	9.07	10.43	50 x 63
68000	383LX683M035N102	0.016	0.012	9.27	10.66	40 x 105
68000	383LX683M035B082V	0.017	0.013	10.07	11.58	50 x 80
82000	383LX823M035B092V	0.015	0.011	10.89	12.52	50 x 92

Cap. (µF)	Catalog Part Number	Max. ESR @ +25°C		Ripple Amps @ +105°C		Nominal Size
		120 Hz (ohms)	20 kHz (ohms)	120 Hz (A)	20 kHz (A)	
		D x L (mm)				
35 Vdc (44 Vdc Surge)						
100000	383LX104M035B102V	0.013	0.010	11.75	13.51	50 x 105
50 Vdc (63 Vdc Surge)						
1000	381LX102M050H202	0.260	0.200	0.90	1.00	22 x 20
1500	381LX152M050H012	0.155	0.120	1.25	1.45	22 x 25
1800	381LX182M050H012	0.129	0.097	1.50	1.70	22 x 25
2200	381LX222M050H012	0.129	0.097	1.50	1.70	22 x 25
2700	381LX272M050H012	0.154	0.115	1.80	2.07	22 x 25
2700	381LX272M050J012*	0.086	0.064	1.80	2.10	25 x 25
3300	381LX332M050H012	0.126	0.094	2.00	2.30	22 x 25
3300	381LX332M050J022	0.070	0.053	2.00	2.30	25 x 30
3900	381LX392M050J012	0.106	0.080	2.20	2.53	25 x 25
3900	381LX392M050K012	0.065	0.050	2.20	2.50	30 x 25
4700	381LX472M050J022	0.053	0.040	2.50	2.90	25 x 30
4700	381LX472M050A012	0.053	0.040	2.50	2.90	35 x 25
5600	381LX562M050J032	0.074	0.056	2.80	3.22	25 x 35
5600	381LX562M050A022	0.050	0.038	2.80	3.20	35 x 30
6800	381LX682M050H452	0.061	0.046	3.30	3.80	22 x 45
6800	381LX682M050A022	0.046	0.035	3.30	3.80	35 x 30
8200	381LX822M050K452	0.051	0.038	3.60	4.10	30 x 45
8200	381LX822M050A032	0.040	0.030	3.60	4.10	35 x 35
10000	381LX103M050J052	0.041	0.031	4.00	4.60	25 x 50
10000	381LX103M050K052	0.033	0.025	4.00	4.60	30 x 50
10000	381LX103M050A042	0.033	0.025	4.00	4.60	35 x 40
12000	381LX123M050A452	0.028	0.021	4.50	5.20	35 x 45
12000	383L123M050N042	0.029	0.018	3.80	4.80	40 x 40
15000	381LX153M050K452	0.028	0.022	4.80	5.52	30 x 45
15000	383LX153M050N042	0.022	0.018	4.80	5.52	40 x 40
15000	383L153M050N052	0.021	0.013	4.90	6.10	40 x 50
18000	381LX183M050A452	0.023	0.018	5.60	6.44	35 x 45
18000	383L183M050N062	0.017	0.011	5.80	7.20	40 x 63
22000	383LX223M050N052	0.016	0.013	5.10	5.90	40 x 50
27000	383LX273M050N062	0.015	0.012	6.05	6.96	40 x 63
27000	383L273M050N082	0.013	0.009	7.40	9.00	40 x 80
33000	383LX333M050B052V	0.018	0.014	7.75	8.91	50 x 50
39000	383LX393M050N082	0.013	0.010	6.20	7.10	40 x 80
39000	383LX393M050B062V	0.016	0.013	8.40	9.66	50 x 63
47000	383LX473M050N102	0.012	0.010	8.18	9.41	40 x 105
47000	383LX473M050B082V	0.014	0.011	9.19	10.57	50 x 80
56000	383LX563M050B092V	0.012	0.009	9.79	11.26	50 x 92
68000	383LX683M050B102V	0.011	0.009	10.40	12.00	50 x 105

*Denotes Discontinued Part

Type 381LX / 383LX 105 °C High Ripple, Snap-In Aluminum

High Ripple, Long Life, 2,4 and 5 pin styles available

Cap. (µF)	Catalog Part Number	Max. ESR		Ripple Amps		Nominal	Cap. (µF)	Catalog Part Number	Max. ESR		Ripple Amps		Nominal
		@ +25°C		@ +105°C		Size			@ +25°C		@ +105°C		Size
		120 Hz (ohms)	20 kHz (ohms)	120 Hz (A)	20 kHz (A)	D x L (mm)			120 Hz (ohms)	20 kHz (ohms)	120 Hz (A)	20 kHz (A)	D x L (mm)
63 Vdc (79 Vdc Surge)							80 Vdc (100 Vdc Surge)						
680	381LX681M063H012	0.410	0.310	0.90	1.00	22 x 25	470	381LX471M080H012	0.390	0.270	0.80	0.90	22 x 25
1000	381LX102M063H012	0.280	0.210	1.18	1.35	22 x 25	680	381LX681M080H012	0.270	0.190	1.00	1.15	22 x 25
1200	381LX122M063H012	0.235	0.180	1.40	1.60	22 x 25	820	381LX821M080H012	0.222	0.145	1.20	1.40	22 x 25
1500	381LX152M063H012	0.235	0.180	1.50	1.70	22 x 25	1000	381LX102M080H012	0.222	0.145	1.20	1.40	22 x 25
1800	381LX182M063H022	0.157	0.117	1.70	1.96	22 x 30	1000	381LX102M080J012*	0.182	0.120	1.30	1.50	25 x 25
1800	381LX182M063J012	0.123	0.092	2.20	2.53	25 x 25	1200	381LX122M080H022	0.235	0.176	1.50	1.73	22 x 30
2200	381LX222M063H022	0.143	0.110	1.50	1.70	22 x 30	1500	381LX152M080H032	0.188	0.141	1.70	1.96	22 x 35
2700	381LX272M063H042	0.123	0.092	2.20	2.53	22 x 40	1800	381LX182M080J032*	0.147	0.080	1.80	2.10	25 x 35
2700	381LX272M063K012	0.105	0.080	2.20	2.50	30 x 25	1800	381LX182M080K012	0.111	0.080	1.80	2.10	30 x 25
3300	381LX332M063J022	0.090	0.070	2.50	2.90	25 x 30	2200	381LX222M080H452	0.121	0.092	2.10	2.40	22 x 45
3300	381LX332M063A012	0.090	0.070	2.50	2.90	35 x 25	2200	381LX222M080A012	0.090	0.063	2.10	2.40	35 x 25
3900	381LX392M063J022	0.085	0.064	2.70	3.11	25 x 30	2700	381LX272M080J042	0.104	0.078	2.40	2.76	25 x 40
3900	381LX392M063J452	0.080	0.060	2.70	3.10	25 x 45	3300	381LX332M080J052	0.065	0.049	2.60	3.00	25 x 50
4700	381LX472M063K042	0.063	0.048	3.00	3.50	30 x 40	3300	381LX332M080K042	0.100	0.075	2.60	3.00	30 x 40
5600	381LX562M063K042	0.059	0.044	3.30	3.80	30 x 40	3300	381LX332M080A022	0.065	0.049	2.60	3.00	35 x 30
5600	381LX562M063K452	0.055	0.040	3.30	3.80	30 x 45	3900	381LX392M080K042	0.072	0.054	3.00	3.45	30 x 40
5600	381LX562M063A032	0.055	0.040	3.30	3.80	35 x 35	4700	381LX472M080K042	0.060	0.045	3.30	3.80	30 x 40
6800	381LX682M063J052	0.050	0.040	3.60	4.10	25 x 50	4700	381LX472M080K052	0.048	0.036	3.30	3.80	30 x 50
6800	381LX682M063K042	0.049	0.037	3.60	4.14	30 x 40	4700	381LX472M080A042	0.048	0.036	3.30	3.80	35 x 40
6800	381LX682M063K052	0.050	0.040	3.60	4.10	30 x 50	5600	381LX562M080A052	0.072	0.054	3.00	3.45	35 x 50
8200	381LX822M063J052	0.040	0.030	3.90	4.50	25 x 50	5600	383L562M080N042	0.035	0.022	3.50	4.40	40 x 40
8200	381LX822M063A452	0.040	0.030	3.90	4.50	35 x 45	6800	381LX682M080A052	0.041	0.031	3.90	4.50	35 x 50
8200	383L822M063N042	0.031	0.018	3.70	4.80	40 x 40	6800	383LX682M080N042	0.041	0.031	3.90	4.49	40 x 40
10000	381LX103M063K452	0.033	0.028	4.40	5.10	30 x 45	8200	383L822M080N052	0.025	0.016	4.40	5.60	40 x 50
10000	381LX103M063K052	0.033	0.028	4.40	5.10	30 x 50	10000	383L103M080N062	0.021	0.013	5.30	6.70	40 x 63
12000	381LX123M063K052	0.030	0.025	4.40	5.06	30 x 50	12000	383LX123M080B052V	0.035	0.026	6.03	6.93	50 x 50
12000	383LX123M063N042	0.030	0.028	4.52	5.20	40 x 40	15000	383L153M080N082	0.015	0.010	6.80	8.40	40 x 80
12000	383L123M063N052	0.022	0.013	4.70	6.10	40 x 50	15000	383LX153M080B062V	0.028	0.021	6.65	7.65	50 x 63
15000	381LX153M063A052	0.024	0.023	4.90	5.70	35 x 50	18000	383LX183M080B082V	0.026	0.019	7.29	8.38	50 x 80
15000	383LX153M063N052	0.027	0.023	4.80	5.50	40 x 50	22000	383LX223M080N102	0.019	0.014	6.95	7.99	40 x 105
15000	383L153M063N062	0.018	0.011	5.70	7.20	40 x 63	22000	383LX223M080B092V	0.022	0.016	7.83	9.00	50 x 92
18000	381LX183M063A082	0.022	0.019	5.80	6.70	35 x 80	27000	383LX273M080B102V	0.018	0.014	8.38	9.64	50 x 105
18000	383LX183M063N062	0.023	0.020	5.40	6.20	40 x 63	100 Vdc (125 Vdc Surge)						
22000	383L223M063N082	0.013	0.009	7.20	9.00	40 x 80	330	381LX331M100H012	0.653	0.392	0.80	1.20	22 x 25
22000	383LX223M063B052V	0.019	0.016	6.76	7.77	50 x 50	470	381LX471M100H012	0.390	0.230	0.92	1.40	22 x 25
27000	383LX273M063N082	0.017	0.014	6.60	7.60	40 x 80	560	381LX561M100H012	0.300	0.180	1.10	1.30	22 x 25
27000	383LX273M063B062V	0.017	0.014	7.34	8.44	50 x 63	680	381LX681M100H012	0.300	0.180	1.10	1.30	22 x 25
33000	383LX333M063B082V	0.015	0.013	8.00	9.20	50 x 80	820	381LX821M100H012	0.303	0.197	1.40	1.60	22 x 25
39000	383LX393M063N102	0.014	0.012	7.53	8.66	40 x 105	820	381LX821M100J012	0.202	0.120	1.40	2.10	25 x 25
39000	383LX393M063B092V	0.014	0.012	8.48	9.75	50 x 92	1000	381LX102M100H022	0.182	0.110	1.70	2.55	22 x 30
47000	383LX473M063B102V	0.012	0.010	8.99	10.34	50 x 105	1200	381LX122M100H022	0.195	0.125	1.85	2.70	22 x 30
							1200	381LX122M100H032*	0.195	0.125	1.85	2.70	22 x 35

*Denotes Discontinued Part

Type 381LX / 383LX 105 °C High Ripple, Snap-In Aluminum

High Ripple, Long Life, 2,4 and 5 pin styles available

Cap. (µF)	Catalog Part Number	Max. ESR		Ripple Amps		Nominal
		@ +25°C		@ +105°C		Size
		120 Hz (ohms)	20 kHz (ohms)	120 Hz (A)	20 kHz (A)	D x L (mm)
100 Vdc (125 Vdc Surge)						
1500	381LX152M100H042	0.155	0.100	2.30	2.80	22 x 40
1500	381LX152M100K012	0.155	0.100	2.30	2.80	30 x 25
1800	381LX182M100J042	0.138	0.090	2.30	2.65	25 x 40
2200	381LX222M100J042	0.121	0.080	2.60	2.99	25 x 40
2200	381LX222M100J452	0.090	0.060	2.60	3.90	25 x 45
2700	381LX272M100A022	0.092	0.060	2.90	3.34	35 x 30
3300	381LX332M100K052	0.075	0.053	3.20	4.80	30 x 50
3300	381LX332M100A042	0.075	0.053	3.20	4.80	35 x 40
3900	381LX392M100K052	0.064	0.043	3.60	4.14	30 x 50
4700	381LX472M100A052	0.053	0.040	3.80	5.70	35 x 50
4700	383LX472M100N042	0.053	0.040	3.80	5.70	40 x 40
5600	381LX562M100A052	0.044	0.033	4.10	4.70	35 x 50
5600	383L562M100N062	0.027	0.012	4.60	6.50	40 x 63
6800	383LX682M100N052	0.037	0.027	4.60	5.30	40 x 50
8200	383LX822M100N062	0.030	0.023	5.00	5.77	40 x 63
8200	383L822M100N082	0.020	0.009	6.00	8.20	40 x 80
8200	383LX822M100B052V	0.030	0.023	6.14	7.06	50 x 50
10000	381LX103M100A082	0.033	0.025	6.38	7.34	35 x 80
12000	383LX123M100N082	0.021	0.016	6.44	7.40	40 x 80
12000	383LX123M100B062V	0.022	0.017	7.17	8.25	50 x 63
15000	383LX153M100N102	0.017	0.012	7.37	8.48	40 x 105
15000	383LX153M100B082V	0.019	0.014	8.01	9.21	50 x 80
18000	383LX183M100B092V	0.017	0.012	8.64	9.94	50 x 92
22000	383LX223M100B102V	0.015	0.011	9.32	10.72	50 x 105
160 Vdc (200 Vdc Surge)						
470	381LX471M160H022	0.423	0.190	1.40	2.00	22 x 30
560	381LX561M160H032	0.355	0.160	1.50	2.10	22 x 35
680	381LX681M160H042	0.293	0.132	1.70	2.40	22 x 40
820	381LX821M160J042	0.243	0.109	2.00	2.80	25 x 40
1000	381LX102M160J042	0.216	0.108	2.20	3.08	25 x 40
1200	381LX122M160K032	0.180	0.090	2.30	3.20	30 x 35
1500	381LX152M160K452	0.155	0.077	2.50	3.50	30 x 45
1800	381LX182M160K452	0.111	0.055	2.70	3.78	30 x 45
2200	381LX222M160K052	0.098	0.049	2.90	4.06	30 x 50
2200	383LX222M160N042	0.100	0.060	2.90	4.10	40 x 40
2700	383L272M160N062	0.045	0.027	3.80	5.00	40 x 63
3300	383LX332M160N052	0.070	0.040	3.40	4.70	40 x 40
180 Vdc (225 Vdc Surge)						
270	381LX271M180H012	0.737	0.376	1.10	1.50	22 x 25
330	381LX331M180H022	0.603	0.308	1.20	1.70	22 x 30
390	381LX391M180J012	0.510	0.260	1.30	1.80	25 x 25
470	381LX471M180H032	0.423	0.216	1.40	2.00	22 x 35

Cap. (µF)	Catalog Part Number	Max. ESR		Ripple Amps		Nominal
		@ +25°C		@ +105°C		Size
		120 Hz (ohms)	20 kHz (ohms)	120 Hz (A)	20 kHz (A)	D x L (mm)
180 Vdc (225 Vdc Surge)						
560	381LX561M180H042	0.355	0.181	1.50	2.10	22 x 40
680	381LX681M180J032	0.293	0.149	1.70	2.38	25 x 35
820	381LX821M180K022	0.243	0.124	2.00	2.80	30 x 30
1000	381LX102M180J052	0.216	0.097	2.20	3.08	25 x 50
1200	381LX122M180K452	0.166	0.085	2.30	3.20	30 x 45
1500	381LX152M180K052	0.133	0.068	2.50	3.50	30 x 50
1800	381LX182M180A452	0.111	0.050	2.70	3.80	35 x 45
1800	383L182M180N052	0.059	0.033	3.10	4.20	40 x 50
2200	381LX222M180A052	0.090	0.046	2.90	4.10	35 x 50
2200	383L222M180N062	0.048	0.027	3.70	4.90	40 x 63
3300	383L332M180N082	0.035	0.020	4.80	6.30	40 x 80
200 Vdc (250 Vdc Surge)						
100	381LX101M200H012	1.660	0.750	0.50	0.70	22 x 25
150	381LX151M200H012	1.100	0.500	0.70	0.95	22 x 25
220	381LX221M200H012	0.754	0.339	1.00	1.40	22 x 25
270	381LX271M200H012	0.730	0.300	1.10	1.50	22 x 25
270	381LX271M200J012	0.614	0.276	1.10	1.50	25 x 25
330	381LX331M200H022	0.603	0.308	1.25	1.79	22 x 30
330	381LX331M200J012	0.603	0.308	1.20	1.70	25 x 25
390	381LX391M200H022	0.510	0.230	1.30	1.80	22 x 30
470	381LX471M200J022	0.423	0.190	1.40	2.00	25 x 30
470	381LX471M200K012	0.353	0.159	1.40	2.00	30 x 25
560	381LX561M200H042	0.355	0.160	1.50	2.10	22 x 40
560	381LX561M200J022	0.355	0.160	1.50	2.10	25 x 30
680	381LX681M200J042	0.293	0.132	1.70	2.40	25 x 40
680	381LX681M200K022	0.244	0.110	1.70	2.40	30 x 30
820	381LX821M200H452	0.263	0.118	2.00	2.80	22 x 45
820	381LX821M200J042	0.243	0.109	2.04	2.92	25 x 40
820	381LX821M200K022	0.263	0.118	2.00	2.80	30 x 30
1000	381LX102M200J052	0.216	0.108	2.20	3.10	25 x 50
1000	381LX102M200K032	0.216	0.108	2.20	3.10	30 x 35
1000	381LX102M200K452	0.216	0.108	2.20	3.10	30 x 45
1000	381LX102M200A022	0.216	0.108	2.20	3.10	35 x 30
1200	381LX122M200K042	0.193	0.097	2.30	3.20	30 x 40
1200	381LX122M200K052	0.193	0.097	2.30	3.20	30 x 50
1200	381LX122M200A032	0.193	0.097	2.30	3.20	35 x 35
1500	381LX152M200K052	0.155	0.077	2.50	3.50	30 x 50
1500	381LX152M200A042	0.155	0.077	2.50	3.50	35 x 40
1800	381LX182M200A452	0.129	0.077	2.70	3.80	35 x 45
1800	383LX182M200N042	0.129	0.077	2.70	3.78	40 x 40
1800	383L182M200N052	0.063	0.033	3.00	4.10	40 x 50
2200	381LX222M200A052	0.105	0.063	2.90	4.00	35 x 50

Type 381LX / 383LX 105 °C High Ripple, Snap-In Aluminum

High Ripple, Long Life, 2,4 and 5 pin styles available

Cap. (µF)	Catalog Part Number	Max. ESR		Ripple Amps		Nominal	Cap. (µF)	Catalog Part Number	Max. ESR		Ripple Amps		Nominal
		@ +25°C		@ +105°C		Size			@ +25°C		@ +105°C		Size
		120 Hz (ohms)	20 kHz (ohms)	120 Hz (A)	20 kHz (A)	D x L (mm)			120 Hz (ohms)	20 kHz (ohms)	120 Hz (A)	20 kHz (A)	D x L (mm)
200 Vdc (250 Vdc Surge)							250 Vdc (300 Vdc Surge)						
2200	383L222M200N062	0.051	0.027	3.60	4.90	40 x 63	1800	383L182M250N062	0.066	0.025	3.10	5.10	40 x 63
2700	383LX272M200N052	0.086	0.052	3.55	4.97	40 x 50	2200	381LX222M250A082	0.096	0.064	3.75	5.25	35 x 80
2700	383L272M200N082	0.032	0.018	4.60	6.20	40 x 80	2200	383LX222M250N062	0.098	0.064	3.70	5.15	40 x 63
3300	381LX332M200A082	0.065	0.039	4.50	6.33	35 x 80	2200	383L222M250N082	0.043	0.017	4.00	6.40	40 x 80
3300	383LX332M200N062	0.700	0.040	4.40	6.20	40 x 63	2200	383LX222M250B052V	0.098	0.064	4.35	6.09	50 x 50
3300	383LX332M200B052V	0.075	0.045	5.20	7.28	50 x 50	2700	383LX272M250N082	0.092	0.047	3.10	4.30	40 x 80
3900	383LX392M200B062V	0.064	0.038	5.90	8.26	50 x 63	2700	383LX272M250B062V	0.080	0.052	4.98	6.97	50 x 63
4700	383LX472M200N082	0.050	0.030	5.75	8.10	40 x 80	3300	383LX332M250N082	0.065	0.042	4.86	6.80	40 x 80
4700	383LX472M200B082V	0.053	0.032	6.82	9.55	50 x 80	3900	383LX392M250N102	0.055	0.036	5.61	7.85	40 x 105
5600	383LX562M200N102	0.041	0.025	6.76	9.46	40 x 105	3900	383LX392M250B082V	0.055	0.036	6.10	8.54	50 x 80
5600	383LX562M200B092V	0.044	0.027	7.68	10.75	50 x 92	4300	383LX432M250B092V	0.050	0.033	6.67	9.34	50 x 92
6800	383LX682M200B102V	0.034	0.020	8.71	12.19	50 x 105	4700	383LX472M250B102V	0.046	0.030	7.03	9.84	50 x 105
250 Vdc (300 Vdc Surge)							315 Vdc (365 Vdc Surge)						
68	381LX680M250H202	2.926	1.493	0.40	0.60	22 x 20	82	381LX820M315H012	2.430	1.240	0.60	0.90	22 x 25
68	381LX680M250H012	2.440	1.220	0.40	0.60	22 x 25	100	381LX101M315H012	1.990	1.020	0.70	1.00	22 x 25
100	381LX101M250H012	1.660	0.830	0.55	0.78	22 x 25	120	381LX121M315H012	1.660	0.850	0.80	1.10	22 x 25
150	381LX151M250H012	1.327	0.465	0.79	0.11	22 x 25	150	381LX151M315H022	1.330	0.600	0.82	1.15	22 x 30
180	381LX181M250H012	1.106	0.553	0.88	1.23	22 x 25	180	381LX181M315H022	1.110	0.550	0.90	1.25	22 x 30
220	381LX221M250H012	0.905	0.452	1.00	1.40	22 x 25	220	381LX221M315H032	0.900	0.410	0.98	1.37	22 x 35
270	381LX271M250H022	0.737	0.332	1.18	1.69	22 x 30	220	381LX221M315K022	0.904	0.461	1.00	1.40	30 x 30
330	381LX331M250H022	0.502	0.251	1.20	1.70	22 x 30	270	381LX271M315J032	0.740	0.330	1.10	1.54	25 x 35
330	381LX331M250J022	0.502	0.251	1.20	1.70	25 x 30	270	381LX271M315K022	0.737	0.376	1.10	1.50	30 x 30
330	381LX331M250J032	0.502	0.251	1.20	1.70	25 x 30	270	381LX271M315K032	0.737	0.376	1.10	1.50	30 x 35
390	381LX391M250J032	0.510	0.229	1.49	2.12	25 x 35	270	381LX271M315A022	0.737	0.376	1.10	1.50	35 x 30
470	381LX471M250J032	0.423	0.191	1.40	1.96	25 x 35	330	381LX331M315J042	0.600	0.270	1.20	1.68	25 x 40
470	381LX471M250K022	0.353	0.176	1.40	2.00	30 x 30	330	381LX331M315K032	0.603	0.308	1.20	1.70	30 x 35
560	381LX561M250J032	0.355	0.160	1.80	2.57	25 x 35	330	381LX331M315K042	0.603	0.308	1.20	1.70	30 x 40
560	381LX561M250K032	0.296	0.148	1.50	2.10	30 x 35	330	381LX331M315A022	0.603	0.308	1.20	1.70	35 x 30
560	381LX561M250A012	0.296	0.148	1.50	2.10	35 x 25	390	381LX391M315K452	0.510	0.260	1.30	1.80	30 x 45
680	381LX681M250J052	0.244	0.134	1.70	2.38	25 x 50	390	381LX391M315A032	0.510	0.260	1.30	1.80	35 x 35
680	381LX681M250K042	0.244	0.134	1.70	2.38	30 x 40	470	381LX471M315K452	0.423	0.216	1.40	2.00	30 x 45
680	381LX681M250A022	0.244	0.134	1.70	2.38	35 x 30	470	381LX471M315K052	0.423	0.216	1.40	2.00	30 x 50
820	381LX821M250K452	0.202	0.111	2.00	2.80	30 x 45	470	381LX471M315A032	0.423	0.216	1.40	2.00	35 x 35
820	381LX821M250A032	0.202	0.111	2.00	2.80	35 x 35	470	381LX471M315A042	0.423	0.216	1.40	2.00	35 x 40
1000	381LX102M250K052	0.199	0.109	2.20	3.10	30 x 50	560	381LX561M315K052	0.355	0.181	1.50	2.10	30 x 50
1000	381LX102M250A042	0.199	0.109	2.20	3.10	35 x 40	560	381LX561M315A042	0.355	0.181	1.50	2.10	35 x 40
1000	381LX102M250A452	0.166	0.099	2.30	3.20	35 x 45	560	381LX561M315A452	0.355	0.181	1.50	2.10	35 x 45
1200	381LX122M250A452	0.166	0.099	2.30	3.20	35 x 45	680	381LX681M315A452	0.293	0.149	1.70	2.40	35 x 45
1200	383LX122M250N042	0.180	0.117	2.66	3.72	40 x 40	680	381LX681M315A052	0.293	0.149	1.70	2.40	35 x 50
1200	383L122M250N052	0.081	0.031	2.60	4.30	40 x 50	820	381LX821M315A052	0.242	0.030	2.00	2.80	35 x 50
1500	381LX152M250A052	0.144	0.093	2.50	3.50	35 x 50	820	383L821M315N052	0.190	0.130	1.70	2.10	40 x 50
1800	383LX182M250N052	0.120	0.078	3.25	4.55	40 x 50	1200	383L122M315N062	0.150	0.110	2.10	2.50	40 x 63
							1500	383L152M315N082	0.110	0.055	2.70	3.20	40 x 80

Type 381LX / 383LX 105 °C High Ripple, Snap-In Aluminum

High Ripple, Long Life, 2,4 and 5 pin styles available

Cap. (µF)	Catalog Part Number	Max. ESR		Ripple Amps		Nominal	Cap. (µF)	Catalog Part Number	Max. ESR		Ripple Amps		Nominal
		@ +25°C		@ +105°C		Size			@ +25°C		@ +105°C		Size
		120 Hz (ohms)	20 kHz (ohms)	120 Hz (A)	20 kHz (A)	D x L (mm)			120 Hz (ohms)	20 kHz (ohms)	120 Hz (A)	20 kHz (A)	D x L (mm)
350 Vdc (400 Vdc Surge)							400 Vdc (450 Vdc Surge)						
82	381LX820M350H012	2.430	1.240	0.60	0.90	22 x 25	150	381LX151M400H022	0.921	0.322	0.90	1.30	22 x 30
100	381LX101M350H022	1.990	1.020	0.70	1.00	22 x 30	150	381LX151M400H032	1.330	0.460	0.80	1.10	22 x 35
120	381LX121M350H022	1.660	0.750	0.75	1.05	22 x 30	150	381LX151M400J012	1.110	0.870	0.80	1.10	25 x 25
150	381LX151M350H022	1.330	0.600	0.77	1.08	22 x 30	180	381LX181M400J022	0.921	0.322	0.90	1.30	25 x 30
180	381LX181M350H032	1.110	0.500	0.87	1.22	22 x 35	180	381LX181M400J032	1.110	0.500	0.95	1.33	25 x 35
220	381LX221M350H042	0.900	0.410	1.00	1.40	22 x 40	180	381LX181M400K022	0.921	0.322	0.90	1.30	30 x 30
270	381LX271M350H452	0.740	0.380	1.10	1.50	22 x 45	220	381LX221M400H452	0.614	0.215	1.20	1.70	22 x 45
270	381LX271M350K022	0.737	0.376	1.10	1.50	30 x 30	220	381LX221M400K022	0.754	0.264	1.10	1.50	30 x 30
330	381LX331M350K042	0.603	0.308	1.20	1.70	30 x 40	220	381LX221M400A012	0.754	0.264	1.10	1.50	35 x 25
330	381LX331M350A022	0.603	0.308	1.20	1.70	35 x 30	270	381LX271M400J052	0.614	0.215	1.20	1.70	25 x 50
390	381LX391M350K452	0.510	0.260	1.30	1.80	30 x 45	270	381LX271M400K032	0.614	0.215	1.20	1.70	30 x 35
390	381LX391M350A022	0.510	0.260	1.30	1.80	35 x 30	270	381LX271M400A022	0.614	0.215	1.20	1.70	35 x 30
470	381LX471M350K052	0.423	0.216	1.40	2.00	30 x 50	330	381LX331M400K452	0.502	0.201	1.40	1.90	30 x 45
470	381LX471M350A042	0.423	0.216	1.40	2.00	35 x 40	330	381LX331M400A032	0.502	0.201	1.40	1.90	35 x 35
560	381LX561M350A452	0.355	0.181	1.50	2.10	35 x 45	390	381LX391M400J452	0.425	0.170	1.55	2.20	25 x 45
560	383L561M350N042	0.299	0.205	1.30	1.50	40 x 40	390	381LX391M400K052	0.425	0.170	1.55	2.20	30 x 50
680	381LX681M350A052	0.293	0.149	1.70	2.40	35 x 50	390	381LX391M400A042	0.425	0.170	1.55	2.20	35 x 40
680	383LX681M350N042	0.317	0.127	2.30	3.22	40 x 40	470	381LX471M400A452	0.353	0.141	1.80	2.50	35 x 45
820	381LX821M350A062	0.303	0.155	2.70	3.70	35 x 63	470	383LX471M400N042	0.353	0.141	1.80	2.50	40 x 40
820	383LX821M350N052	0.303	0.155	2.70	3.70	40 x 50	560	381LX561M400A052	0.296	0.118	1.80	2.50	35 x 50
1000	383L102M350N062	0.170	0.117	2.00	2.40	40 x 63	680	383LX681M400N052	0.244	0.098	2.20	3.00	40 x 50
1000	383LX102M350B052V	0.216	0.066	3.56	4.96	50 x 50	820	381LX821M400A062	0.202	0.081	2.44	3.42	35 x 63
1200	381LX122M350A082	0.207	0.106	3.20	4.50	35 x 80	820	383LX821M400B052V	0.202	0.081	3.20	4.40	50 x 50
1200	383LX122M350N062	0.207	0.106	3.20	4.50	40 x 63	1000	381LX102M400A082	0.202	0.081	3.00	4.20	35 x 80
1500	381LX152M350A102	0.144	0.057	4.78	6.69	35 x 105	1000	383LX102M400N062	0.202	0.081	3.00	4.20	40 x 63
1500	383LX152M350N082	0.166	0.085	3.80	5.25	40 x 80	1200	381LX122M400A102	0.138	0.055	3.80	5.30	35 x 105
1500	383LX152M350B062V	0.144	0.057	4.16	5.82	50 x 63	1200	383LX122M400N082	0.138	0.055	3.80	5.30	40 x 80
1800	383LX182M350N102	0.120	0.048	5.23	7.32	40 x 105	1200	383LX122M400B062V	0.152	0.061	4.20	5.90	50 x 63
1800	383LX182M350B082V	0.120	0.048	5.69	7.97	50 x 80	1500	383LX152M400N102	0.111	0.044	4.80	6.70	40 x 105
2000	383LX202M350B092V	0.108	0.043	6.34	8.88	50 x 92	1500	383LX152M400B082V	0.122	0.049	5.20	7.30	50 x 80
2200	383LX222M350B102V	0.098	0.039	6.60	9.30	50 x 105	1600	383LX162M400B092V	0.114	0.046	5.60	8.00	50 x 92
400 Vdc (450 Vdc Surge)							420 Vdc (470 Vdc Surge)						
33	381LX330M400H202	5.020	1.760	0.20	0.30	22 x 20	100	381LX101M420H022	1.820	0.820	0.65	0.90	22 x 30
47	381LX470M400H012	4.500	1.600	0.30	0.42	22 x 25	120	381LX121M420H022	1.660	0.750	0.70	1.00	22 x 30
56	381LX560M400H012	3.530	1.240	0.47	0.66	22 x 25	150	381LX151M420H042	1.330	0.600	0.79	1.11	22 x 40
68	381LX680M400H012	2.927	1.020	0.45	0.60	22 x 25	180	381LX181M420H042	1.110	0.500	0.87	1.22	22 x 40
68	381LX680M400J012	1.950	0.683	0.60	0.80	25 x 25	180	381LX181M420K022	1.000	0.450	0.88	1.20	30 x 30
82	381LX820M400H012*	2.440	0.850	0.55	0.80	22 x 25	220	381LX221M420H452	0.900	0.410	1.05	1.50	22 x 45
100	381LX101M400H022	1.658	0.580	0.50	0.70	22 x 30	220	381LX221M420K022	0.750	0.260	1.10	1.50	30 x 30
100	381LX101M400J012	1.658	0.580	0.70	1.00	25 x 25	270	381LX271M420J452	0.740	0.330	1.19	1.67	25 x 45
120	381LX121M400J012	1.100	0.387	0.80	1.10	25 x 25	270	381LX271M420K032	0.610	0.210	1.20	1.70	30 x 35
120	381LX121M400J022*	1.100	0.387	0.80	1.10	25 x 30							

*Denotes Discontinued Part

Type 381LX / 383LX 105 °C High Ripple, Snap-In Aluminum

High Ripple, Long Life, 2,4 and 5 pin styles available

Cap. (µF)	Catalog Part Number	Max. ESR @ +25°C		Ripple Amps @ +105°C		Nominal Size D x L (mm)
		120 Hz (ohms)	20 kHz (ohms)	120 Hz (A)	20 kHz (A)	
		420 Vdc (470 Vdc Surge)				
270	381LX271M420A022	0.610	0.210	1.20	1.70	35 x 30
330	381LX331M420K452	0.500	0.200	1.35	1.90	30 x 45
330	381LX331M420A032	0.502	0.200	1.35	1.90	35 x 35
390	381LX391M420K052	0.420	0.170	1.55	2.18	30 x 50
390	381LX391M420A042	0.420	0.170	1.55	2.18	35 x 40
470	381LX471M420A452	0.350	0.141	1.75	2.45	35 x 45
470	383LX471M420N042	0.350	0.141	1.78	2.45	40 x 40
560	381LX561M420A052	0.300	0.120	1.80	2.50	35 x 50
680	383LX681M420N052	0.250	0.100	2.10	2.95	40 x 50
450 Vdc (500 Vdc Surge)						
56	381LX560M450H012	3.530	1.240	0.47	0.66	22 x 25
68	381LX680M450H012	2.930	1.020	0.53	0.73	22 x 25
82	381LX820M450H022	2.430	1.090	0.64	0.91	22 x 30
100	381LX101M450H022	1.990	0.710	0.65	0.90	22 x 30
100	381LX101M450J022*	1.660	0.580	0.65	0.90	25 x 30
120	381LX121M450H032	1.660	0.750	0.70	1.00	22 x 35
150	381LX151M450H032	1.330	0.590	0.80	1.10	22 x 35
150	381LX151M450K022	1.100	0.390	0.80	1.10	30 x 30
180	381LX181M450J032	1.110	0.380	0.90	1.20	25 x 35
180	381LX181M450K032	0.920	0.320	0.90	1.20	30 x 35
220	381LX221M450J052	0.750	0.260	1.00	1.40	25 x 50
220	381LX221M450K042	0.750	0.260	1.00	1.40	30 x 40
220	381LX221M450A022	0.750	0.260	1.00	1.40	35 x 30
220	381LX221M450A042	0.500	0.176	1.40	1.90	35 x 40
270	381LX271M450K452	0.614	0.246	1.20	1.70	30 x 45
270	381LX271M450A032	0.614	0.246	1.20	1.70	35 x 35
330	381LX331M450K052	0.502	0.201	1.40	1.90	30 x 50
330	381LX331M450A042	0.502	0.176	1.40	1.90	35 x 40
390	381LX391M450A452	0.425	0.150	1.60	2.20	35 x 45

Cap. (µF)	Catalog Part Number	Max. ESR @ +25°C		Ripple Amps @ +105°C		Nominal Size D x L (mm)
		120 Hz (ohms)	20 kHz (ohms)	120 Hz (A)	20 kHz (A)	
		450 Vdc (500 Vdc Surge)				
390	383LX391M450N042	0.425	0.170	1.68	2.35	40 x 40
470	381LX471M450A052	0.353	0.123	1.70	2.40	35 x 50
470	383LX471M450N042	0.350	0.140	1.75	2.45	40 x 40
560	381LX561M450A062	0.296	0.104	2.20	3.00	35 x 63
680	383L681M450A082	0.188	0.124	2.00	2.50	35 x 80
680	383LX681M450N062	0.244	0.085	2.50	3.50	40 x 63
680	383LX681M450B052V	0.244	0.085	2.90	4.06	50 x 50
820	383LX821M450A082	0.202	0.071	2.70	3.80	35 x 80
820	383LX821M450B062V	0.222	0.078	3.42	4.79	50 x 63
1000	383LX102M450N082	0.166	0.058	3.50	4.90	40 x 80
1200	383LX122M450N102	0.138	0.048	4.33	6.06	40 x 105
1200	383LX122M450B082V	0.152	0.053	4.70	6.58	50 x 80
1300	383LX132M450B092V	0.140	0.049	5.16	7.25	50 x 92
1500	383LX152M450B102V	0.122	0.043	6.03	8.44	50 x 105
500 Vdc (550 Vdc Surge)						
190	381LX191M500A032	0.866	0.703	1.02	1.55	35 x 35
240	381LX241M500A042	0.678	0.550	1.19	1.81	35 x 40
270	381LX271M500A452	0.593	0.481	1.31	2.00	35 x 45
340	381LX341M500A052	0.475	0.385	1.50	2.29	35 x 50
550 Vdc (600 Vdc Surge)						
150	381LX151M550A032	1.195	0.923	0.85	1.36	35 x 35
200	381LX201M550A042	0.935	0.723	1.00	1.59	35 x 40
230	381LX231M550A452	0.818	0.632	1.10	1.75	35 x 45
280	381LX281M550A052	0.655	0.506	1.26	2.00	35 x 50
600 Vdc (650 Vdc Surge)						
140	381LX141M600A032	1.319	1.044	1.40	2.49	35 x 35
180	381LX181M600A042	1.032	0.817	1.64	2.91	35 x 40
210	381LX211M600A452	0.903	0.715	1.80	3.21	35 x 45
260	381LX261M600A052	0.723	0.572	2.07	3.68	35 x 50

*Denotes Discontinued Part

Notice and Disclaimer: All product drawings, descriptions, specifications, statements, information and data (collectively, the "Information") in this datasheet or other publication are subject to change. The customer is responsible for checking, confirming and verifying the extent to which the Information contained in this datasheet or other publication is applicable to an order at the time the order is placed. All Information given herein is believed to be accurate and reliable, but it is presented without any guarantee, warranty, representation or responsibility of any kind, expressed or implied. Statements of suitability for certain applications are based on the knowledge that the Cornell Dubilier company providing such statements ("Cornell Dubilier") has of operating conditions that such Cornell Dubilier company regards as typical for such applications, but are not intended to constitute any guarantee, warranty or representation regarding any such matter – and Cornell Dubilier specifically and expressly disclaims any guarantee, warranty or representation concerning the suitability for a specific customer application, use, storage, transportation, or operating environment. The Information is intended for use only by customers who have the requisite experience and capability to determine the correct products for their application. Any technical advice inferred from this Information or otherwise provided by Cornell Dubilier with reference to the use of any Cornell Dubilier products is given gratis (unless otherwise specified by Cornell Dubilier), and Cornell Dubilier assumes no obligation or liability for the advice given or results obtained. Although Cornell Dubilier strives to apply the most stringent quality and safety standards regarding the design and manufacturing of its products, in light of the current state of the art, isolated component failures may still occur. Accordingly, customer applications which require a high degree of reliability or safety should employ suitable designs or other safeguards (such as installation of protective circuitry or redundancies or other appropriate protective measures) in order to ensure that the failure of an electrical component does not result in a risk of personal injury or property damage. Although all product-related warnings, cautions and notes must be observed, the customer should not assume that all safety measures are indicated in such warnings, cautions and notes, or that other safety measures may not be required.