

# Hardware

## DRESS NUTS

Switchlocks: Y, H & A Series

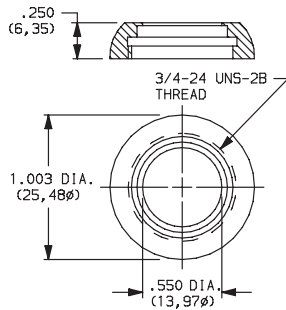

PART NO.

- 531300201** NICKEL PLATED
- 175052745** ALUMINIUM BLACK ANODIZE

Toggles: T Series  
Pushbuttons: TP Series

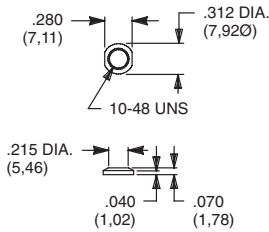

PART NO.

- 298D01201** NICKEL PLATED
- 298D01A56** BLACK

Pushbuttons: 8020, 8060, 8500 & TP Series

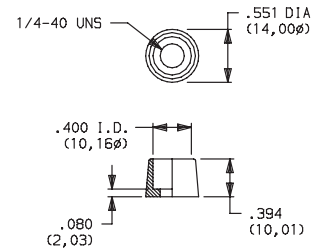

PART NO.

- 580700201** NICKEL PLATED

Pushbuttons: 8020, 8060, E010 & TP Series

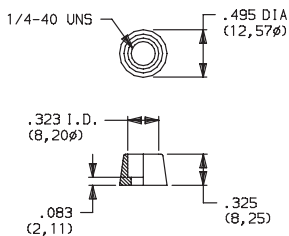

PART NO.

- 702501201** NICKEL PLATED
- 702501A56** BLACK

Toggles: 7000, 9000, E & T Series  
Pushbuttons: 8020, 8060, 8500, E010 & TP Series

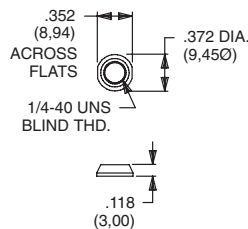

PART NO.

- 709901201** NICKEL PLATED
- 709901215** SATIN CHROME
- 709901A56** BLACK

Toggles: 7000, 9000, E & T Series  
Pushbuttons: 8020, 8060, 8500, E010 & TP Series

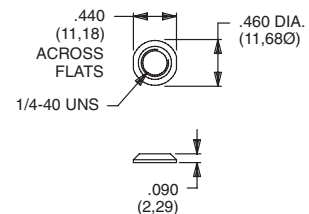

PART NO.

- 776001201** NICKEL PLATED
- 776002231** BLACK

Toggles: 7000, 9000, E & T Series  
Pushbuttons: 8020, 8060, 8500, E010 & TP Series

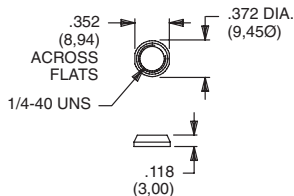

PART NO.

- 299D01201** NICKEL PLATED
- 299D01215** SATIN CHROME
- 299D01A56** BLACK

Pushbuttons: 8500 Series

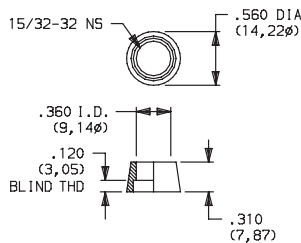

PART NO.

- 498800201** NICKEL PLATED

Toggles: 7000 Series, T2P Actuator

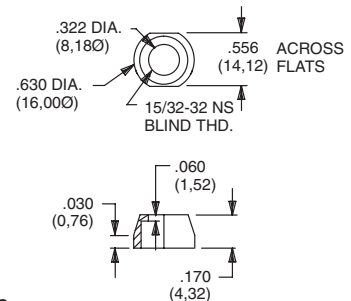

PART NO.

- 605300201** NICKEL PLATED

Toggles: 7000 & 9000 Series  
Pushbuttons: 8500 Series

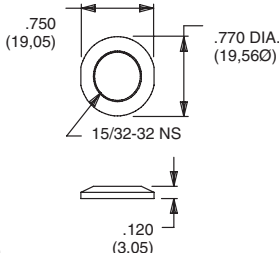

PART NO.

- 895101201** NICKEL PLATED
- 895101A56** BLACK

Toggles: 7000 Series  
Pushbuttons: 8020 & 8060 Series

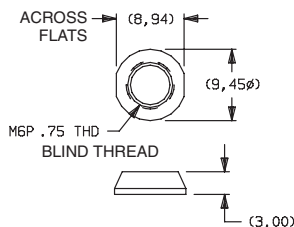

PART NO.

- 709903201** NICKEL PLATED
- 709903A56** BLACK

### MATERIAL

Brass, nickel plated standard. Other finishes available, consult Customer Service center.

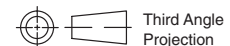

Third Angle Projection

Additional Hardware Information



N



Dimensions are shown: Inch (mm)  
Specifications and dimensions subject to change

## KNURLED NUTS

Toggles: 7000, 9000 & T Series  
Pushbuttons: 8020, 8060, 8500 & TP Series

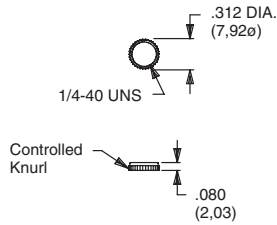

**PART NO.**  
**778000201** NICKEL PLATED  
**778000A56** BLACK

Toggles: 7000, 9000, E & T Series  
Pushbuttons: 8020, 8060, 8500, E010 & TP Series

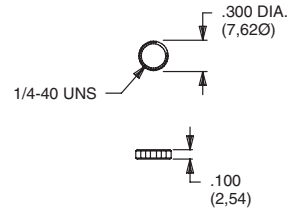

**PART NO.**  
**778600201** NICKEL PLATED  
**778600A56** BLACK

Toggles: 7000, 9000 & T Series  
Pushbuttons: 8020, 8060, 8500 & TP Series  
Fits Gulmite #12 Socket & Wrench 8942-02-201

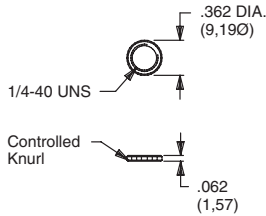

**PART NO.**  
**796901201** NICKEL PLATED  
**796901A56** BLACK

Toggles: 7000 & 9000 Series  
Pushbuttons: 8500 Series  
Will not fit T, T1, TP & T1P Toggles

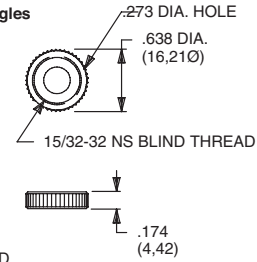

**PART NO.**  
**471300201** NICKEL PLATED  
**471300A56** BLACK

Toggles: 7000 Series  
Pushbuttons: 8020 & 8060 Series

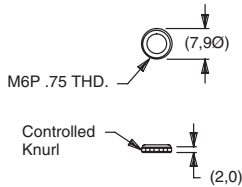

**PART NO.**  
**483200201** NICKEL PLATED

### MATERIAL

Brass, nickel plated standard. Other finishes available, consult Customer Service center.

## LOCKING RINGS

Toggles: T Series  
Pushbuttons: TP Series  
Fits 10-48 Bushing

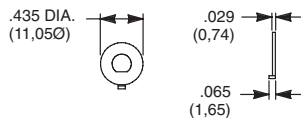

**PART NO.**  
**465000201** NICKEL PLATED WITH FLAT

Toggles: 7000, 9000 & T Series  
Pushbuttons: 8020, 8060, 8500 & TP Series  
Rotary: M Series  
Fits 1/4-40 Bushing

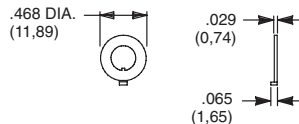

**PART NO.**  
**700701201** NICKEL PLATED WITH KEYWAY  
**700701A56** BLACK WITH KEYWAY

### PANEL MOUNT ASSEMBLY

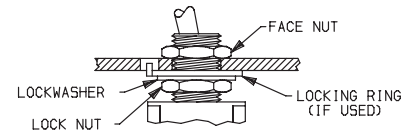

### TYPICAL ASSEMBLY WITH LOCKING RING

**NOTE:** We recommend that locknut always be used with non-flanged bushings.

**CAUTION:** To avoid damaging panel front, always tighten locknut at back of panel. Overtightening mounting nut may cause K2-K12 actuators to bind.

### MATERIAL

Brass, nickel plated standard. Other finishes available, consult Customer Service Center.



# Hardware

## LOCKING RINGS

Toggles: T Series  
Pushbuttons: TP Series  
Fits 10-48 Bushing

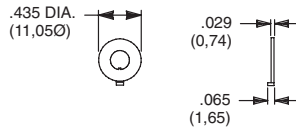

PART NO.

**465101201** NICKEL PLATED WITH KEYWAY

Toggles: 7000, 9000 & T Series  
Pushbuttons: 8020, 8060, 8500 & TP Series  
Rotary: M Series  
Fits 1/4-40 Bushing

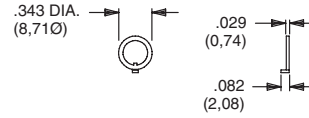

PART NO.

**753700201** NICKEL PLATED WITH KEYWAY  
**753700A56** BLACK WITH KEYWAY

Toggles: 7000 & 9000 Series  
Pushbuttons: 8500 Series  
Fits 15/32 Bushing

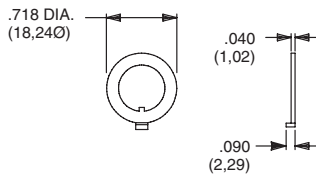

PART NO.

**707200201** NICKEL PLATED WITH KEYWAY  
**707200A56** BLACK WITH KEYWAY

Toggles: 7000, 9000 & T Series  
Pushbuttons: 8020, 8060, 8500 & TP Series  
Rotary: M Series  
Fits 1/4-40 Bushing

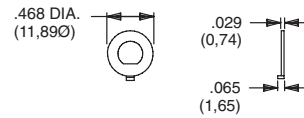

PART NO.

**757200201** NICKEL PLATED WITH FLAT  
**757200A56** BLACK WITH FLAT

Toggles: 7000 Series  
Pushbuttons: 8020 & 8060 Series  
Fits M6P2 Metric Bushing

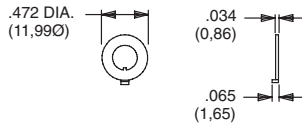

PART NO.

**791800201** NICKEL PLATED WITH KEYWAY  
**791800A56** BLACK WITH KEYWAY

Toggles: 7000, 9000 & T Series  
Pushbuttons: 8020, 8060, 8500 & TP Series  
Rotary: M Series  
Fits 1/4-40 Bushing

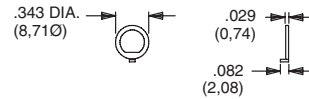

PART NO.

**757300201** NICKEL PLATED WITH FLAT  
**757300A56** BLACK WITH FLAT

### MATERIAL

Brass, nickel plated standard. Other finishes available, consult Customer Service Center.

## LOCKWASHERS

Toggles: T Series  
Pushbuttons: TP Series  
Fits 10-48 Bushing

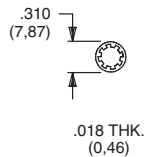

PART NO.

**465200202** NICKEL PLATED

Toggles: 7000 & 9000 Series  
Pushbuttons: 8500 Series  
Fits 15/32 Bushing

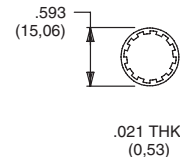

PART NO.

**700302202** NICKEL PLATED  
**700302A56** BLACK

### MATERIAL

Steel, nickel plated standard. Other finishes available, consult Customer Service Center.



Third Angle Projection

Dimensions are shown: Inch (mm)  
Specifications and dimensions subject to change



## LOCKWASHERS

Toggles: 7000, 9000, E & T Series  
Pushbuttons: 8020, 8060, 8500, E010 & TP Series  
Fits 1/4-40 Bushing

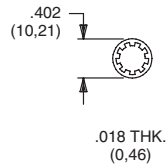

PART NO.

**700303202** NICKEL PLATED  
**700303A56** BLACK

Switchlocks: A, BY, H, W, Y & YL Series  
Fits 3/4 Dia. Bushing

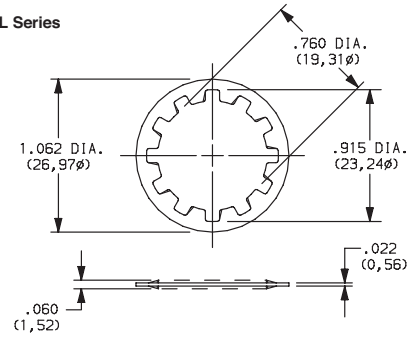

PART NO.

**175050200** ZINC PLATED

Rotary: A & RTA Series  
Fits 3/8 Dia. Thread  
M10 X .75 metric

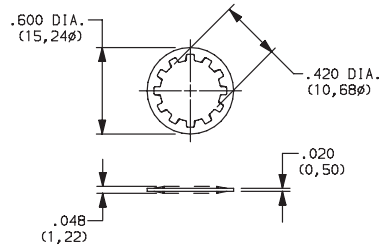

PART NO.

**472800202**

NICKEL PLATED

Pushbutton: 8700 Series  
Rotary: F Series  
Fits 5/16 Dia. Thread

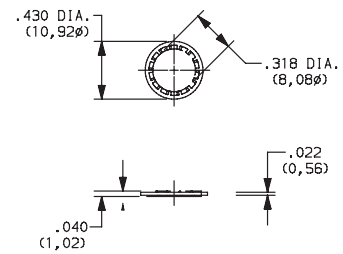

PART NO.

**135A00000**

ZIINC PLATED

### MATERIAL

Steel, nickel plated standard. Other finishes available, consult Customer Service Center.

## MOUNTING NUTS

Pushbuttons: 8600 Series

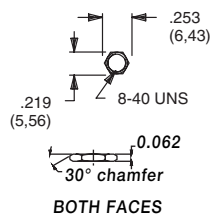

PART NO.

**775200201** NICKEL PLATED  
**775200A56** BLACK

Toggles: T Series  
Pushbuttons: TP Series

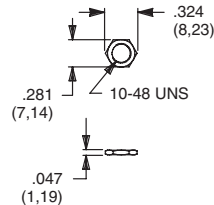

PART NO.

**464900201** NICKEL PLATED  
**464900A56** BLACK

Rotary: M Series

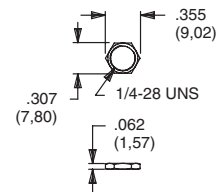

PART NO.

**477100201** NICKEL PLATED

Toggles: E Series  
Pushbuttons: E010 Series

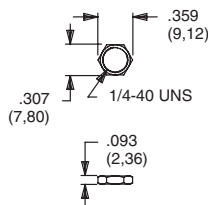

PART NO.

**540400201** NICKEL PLATED  
**540400A56** BLACK

Toggles: 7000, 9000 & T Series  
Pushbuttons: 8020, 8060, 8500 & TP Series

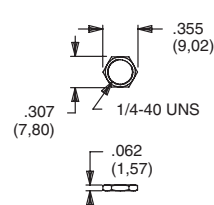

PART NO.

**700201201** NICKEL PLATED  
**700201A56** BLACK

Toggles: 7000 & 9000 Series  
Pushbuttons: 8500 Series

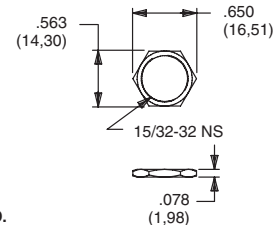

PART NO.

**707100201** NICKEL PLATED  
**707100215** SATIN CHROME  
**707100A56** BLACK

### MATERIAL

Brass, nickel plated standard. Other finishes available, consult Customer Service Center.



Additional Hardware Information



N

# Hardware

## MOUNTING NUTS

Toggles: 7000 Series  
Pushbuttons: 8020 & 8060 Series

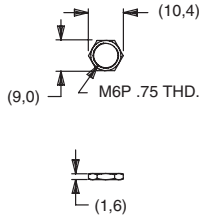

**PART NO.**  
**791600201** NICKEL PLATED  
**791600A56** BLACK

Switchlocks: A, BY, H, P, W, Y & YL Series

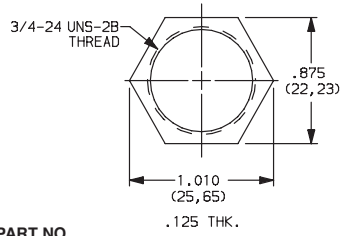

**PART NO.**  
**937C00000**  
ZINC PLATE

Rotary: A & RTA Series

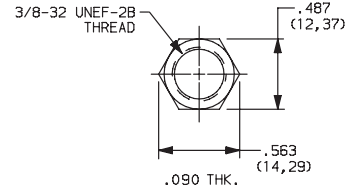

**PART NO.**  
**472706201**  
NICKEL PLATED

Rotary: A & RTA Series

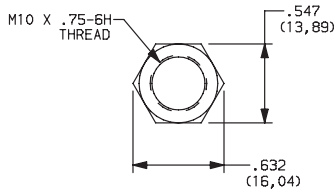

**PART NO.**  
**495100201**  
NICKEL PLATED

Rotary: H & R Series

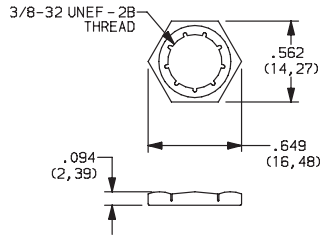

**PART NO.**  
**925C00000**  
ZINC, YELLOW TRIVALENT CHROMIUM

Rotary: F Series

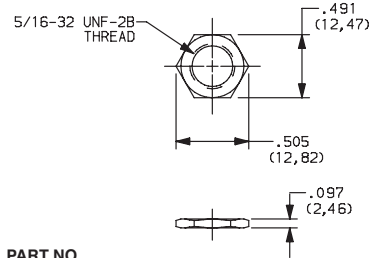

**PART NO.**  
**175020201**  
NICKEL PLATED

Switchlocks: YM Series

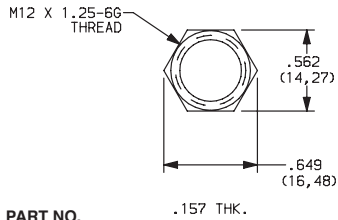

**PART NO.**  
**1790901A47**  
ZINC PLATED, CLEAR TRIVALENT CHROMIUM

Pushbutton: 8700 Series

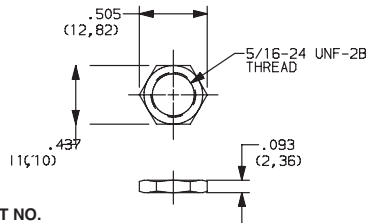

**PART NO.**  
**281B00201**  
NICKEL PLATED

### MATERIAL

Brass, nickel plated standard. Other finishes available, consult Customer Service Center.

Additional Hardware Information



N



Third Angle Projection



Dimensions are shown: Inch (mm)  
Specifications and dimensions subject to change