

REF 100-11/12

DC centrifugal compact fan

single-intake



ebm-papst St. Georgen GmbH & Co. KG

Hermann-Papst-Str. 1
D-78112 St. Georgen
Phone +49 (0) 7724 81-0
Fax +49 (0) 7724 81-1309
info2@de.ebmpapst.com
www.ebmpapst.com

Nominal data

Type	REF 100-11/12	
Nominal voltage	VDC	12
Nominal voltage range	VDC	8 .. 15
Speed (rpm)	min ⁻¹	5400
Power consumption	W	7.5
Min. ambient temperature	°C	-20
Max. ambient temperature	°C	75
Air flow	m ³ /h	86
Sound power level	B	6.3

ml = Max. load · me = Max. efficiency · fa = Free air · cs = Customer specification · ce = Customer equipment
Subject to change



DC centrifugal compact fan

single-intake

Technical description

General description	Backward-curved impeller
Weight	0.160 kg
Dimensions	Ø 100 x 25 mm
Impeller material	Glass-fiber reinforced plastic
Housing material	Scroll housing made of glass-fiber reinforced plastic.
Airflow direction	Axial intake, radial discharge from outlet.
Direction of rotation	Clockwise, viewed toward rotor
Bearing	Ball bearing
Service life L10 at 40 °C	80000 h
Service life L10 at maximum temperature	30000 h
Cable	With leads AWG 22, TR 64
Motor protection	Protection against reverse polarity and blocked rotor.
Locked-rotor protection	With electronic locked-rotor and overload protection.
Approval	CE
Option	Speed signal



Product drawing

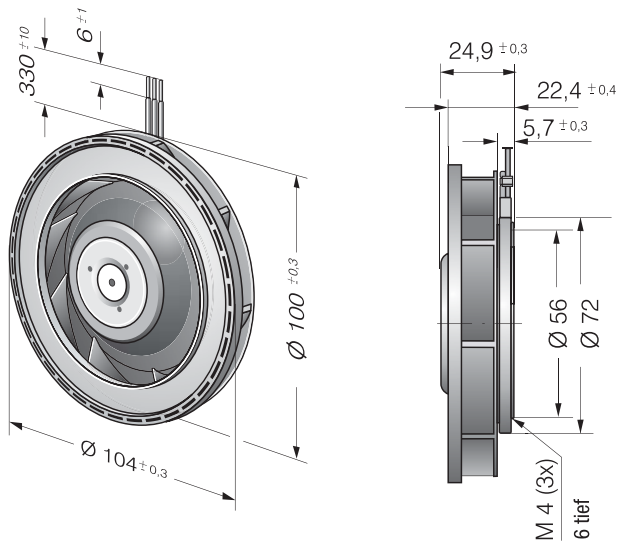

Curves: Air performance

