

TRS 60VUC 2CO**Weidmüller Interface GmbH & Co. KG**

Klingenbergstraße 26

D-32758 Detmold

Germany

www.weidmueller.com

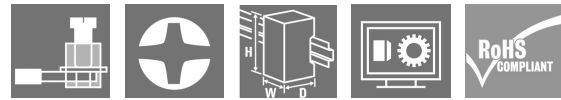
Product image

Similar to illustration

- 2 CO contacts
- Contact material: AgNi
- Unique multi-voltage input from 24 to 230 V UC
- Input voltages from 5 V DC to 230 V UC with coloured marking: AC: red, DC: blue, UC: white

General ordering data

Version	TERMSERIES, Relay module, Number of contacts: 2, CO contact AgNi, Rated control voltage: 60 V UC $\pm 10\%$, Continuous current: 8 A, Screw connection, Test button available: No
Order No.	1123520000
Type	TRS 60VUC 2CO
GTIN (EAN)	4032248905911
Qty.	10 pc(s).

Creation date December 4, 2023 11:41:21 AM CET

Catalogue status 24.11.2023 / We reserve the right to make technical changes.

TRS 60VUC 2CO

Weidmüller Interface GmbH & Co. KG

Klingenbergstraße 26

D-32758 Detmold

Germany

www.weidmueller.com

Technical data

Dimensions and weights

Depth	87.8 mm	Depth (inches)	3.457 inch
Height	89.6 mm	Height (inches)	3.528 inch
Width	12.8 mm	Width (inches)	0.504 inch
Net weight	57 g		

Temperatures

Storage temperature	-40 °C...85 °C	Operating temperature	-40 °C...60 °C
Humidity	5-95% relative humidity, T _u = 40°C, without condensation		

Rated data UL

Ambient temperature (operational), max. 60 °C		Connection cross-section AWG, min.	AWG 26
Connection cross-section AWG, max.	AWG 14	Type of conductor	rigid copper conductor, flexible copper conductor
Tightening torque, max.	0.4 Nm	Pollution severity level	2

Control side

Rated control voltage	60 V UC ±10 %	Rated current AC	8.3 mA
Rated current DC	6.0 mA	Power rating	360 mW, 500 mVA
Status indicator	Green LED	Protective circuit	Rectifier
Coil voltage of the replacement relay deviating from the rated control voltage	Yes	Coil voltage of the replacement relay	60 V DC

Load side

Rated switching voltage	250 V AC	Continuous current	8 A
Max. switching frequency at rated load	0.1 Hz	Max. switching voltage, AC	250 V
Max. switching voltage, DC	250 V	Inrush current	15 A / 4 s
AC switching capacity (resistive), max.	2000 VA	DC switching capacity (resistive), max.	192 W @ 24 V
Switch-on delay	≤ 11 ms	Switch-off delay	≤ 7 ms
Contact type	2 CO contact (AgNi)	Mechanical service life	30 x 10 ⁶ switching cycles
Min. switching power	1 mA @ 24 V, 10 mA @ 10 V, 100 mA @ 5 V		

General data

Operating altitude	≤ 2000 m, above sea level	
Rail	TS 35	
Test button available	No	
Mechanical switch position indicator	No	
Colour	black	
UL94 flammability rating component	Component	Housing
	UL94 flammability rating	V-0
	Component	Retaining clip
	UL94 flammability rating	V-0

TRS 60VUC 2CO

Weidmüller Interface GmbH & Co. KG

Klingenbergstraße 26

D-32758 Detmold

Germany

www.weidmueller.com

Technical data

Insulation coordination

Rated voltage	300 V	Pollution severity	2
Surge voltage category	III	Clearance and creepage distances for control side - load side	≥ 6 mm
Dielectric strength for control side - load side	3.51 kV _{eff} / 1 min.	Type of isolation at input and output	reinforced insulation
Dielectric strength of neighbouring contacts	2.5 kV _{eff} / 1 Min.	Type of isolation at neighbouring contacts	Basic insulation
Dielectric strength of open contact	1 kV _{eff} / 1 min	Dielectric strength to mounting rail	4 kV _{eff} / 1 Min.
Impulse withstand voltage	6 kV (1.2/50 µs)	Protection degree	IP20

Further details of approvals / standards

Certificate No. (DNV)	TAA00001E5	Certificate no. (cULus)	E141197
-----------------------	------------	-------------------------	---------

Connection data

Wire connection method	Screw connection	Stripping length, rated connection	8 mm
Tightening torque, max.	0.4 Nm	Clamping range, rated connection	1.5 mm ²
Clamping range, min.	0.14 mm ²	Clamping range, max.	2.5 mm ²
Wire connection cross section AWG, min.	AWG 26	Wire connection cross section AWG, max.	AWG 14
Wire cross-section, solid, min.	0.14 mm ²	Wire cross-section, solid, max.	2.5 mm ²
Wire cross-section, solid, min. (AWG)	AWG 26	Wire cross-section, solid, max. (AWG)	AWG 14
Wire connection cross section, finely stranded, min.	0.14 mm ²	Wire connection cross section, finely stranded, max.	2.5 mm ²
Wire cross-section, finely stranded, min. (AWG)	AWG 26	Wire cross-section, finely stranded, max. (AWG)	AWG 16
Wire connection cross-section, finely stranded with wire-end ferrules DIN 46228/4, min.	0.25 mm ²	Wire connection cross-section, finely stranded with wire-end ferrules DIN 46228/4, max.	2.5 mm ²
Conductor cross-section, flexible, AEH (DIN 46228-1), min.	0.25 mm ²	Conductor cross-section, flexible, AEH (DIN 46228-1), max.	1.5 mm ²
Wire connection cross section, finely stranded, two clampable wires, min.	0.5 mm ²	Wire cross-section, finely stranded, two clampable wires, max.	1 mm ²
Twin wire-end ferrules, min.	0.5 mm ²	Twin wire-end ferrules, max.	1 mm ²
Blade size	size PHO		

Classifications

ETIM 6.0	EC001437	ETIM 7.0	EC001437
ETIM 8.0	EC001437	ETIM 9.0	EC001437
ECLASS 9.0	27-37-16-01	ECLASS 9.1	27-37-16-01
ECLASS 10.0	27-37-16-01	ECLASS 11.0	27-37-16-01
ECLASS 12.0	27-37-16-01	ECLASS 13.0	27371601

Environmental Product Compliance

REACH SVHC	Lead 7439-92-1
SCIP	9e2cbc49-76d9-4611-b8ec-5b4f549a0aa9

TRS 60VUC 2CO

Weidmüller Interface GmbH & Co. KG
 Klingenbergstraße 26
 D-32758 Detmold
 Germany

www.weidmueller.com

Technical data

Approvals

Approvals



ROHS	Conform
UL File Number Search	UL Website
Certificate no. (cULus)	E141197

Downloads

Approval/Certificate/Document of Conformity	EU Konformitätserklärung / EU Declaration of Conformity
Engineering Data	CAD data – STEP
Engineering Data	Zuken E3.S
User Documentation	Beipackzettel / Package Insert – multilingual
Catalogues	Catalogues in PDF-format
Brochures	

TRS 60VUC 2CO

Weidmüller Interface GmbH & Co. KG
 Klingenbergstraße 26
 D-32758 Detmold
 Germany

www.weidmueller.com

Drawings

Wiring diagram

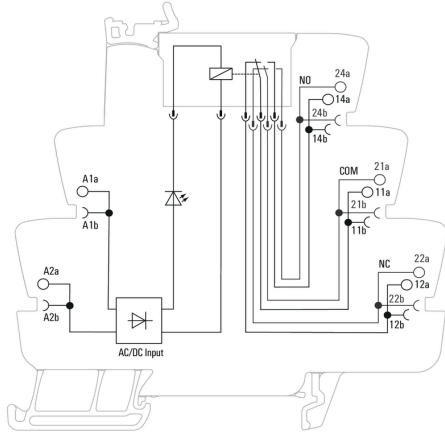

Graph

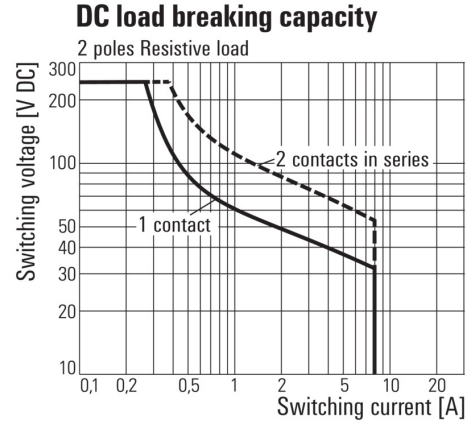

DC load limit curve

Resistive load

Graph

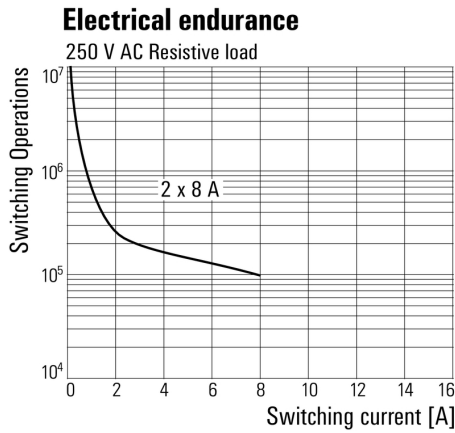

Electrical service life 230 V AC resistive load
 230 V AC resistive load

Dimensional drawing

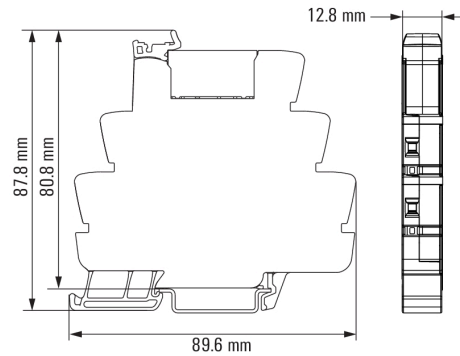

TRS 60VUC 2CO

Weidmüller Interface GmbH & Co. KG
 Klingenbergstraße 26
 D-32758 Detmold
 Germany

www.weidmueller.com

Accessories

Blank



WS markers are the perfect match for the W-series connectors. Thanks to their system compatibility, the WS tags can also be used with the I-series and the Z-series. The large marking surfaces do not only permit long character strings but also multi-line text. WS markers are ideal for labels with long, customised character strings. Thanks to the proven MultiCard format, printing with PrintJet CONNECT oder/or Plotter is possible.

- Can be fitted in strips or individually
- Markers in proven MultiCard format

For custom printing: Please send us a file of our labeling software M-Print PRO or M-Print PRO Online (without installation) for your labeling specifications.

General ordering data

Type	WS 10/6 M MC NE WS	Version
Order No.	1818400000	WS, Terminal marker, 10 x 6 mm, Pitch in mm (P): 6.00 Weidmueller,
GTIN (EAN)	4032248310876	Allen-Bradley, white
Qty.	600 pc(s).	

TRS 60VUC 2CO

Weidmüller Interface GmbH & Co. KG
Klingenbergstraße 26
D-32758 Detmold
Germany

www.weidmueller.com

Accessories

Partition plate



Versatile separation plates

Separation plates can be used to group together signals visually, to electrically isolate modules and to insert markings for a better overview. This makes them a particularly versatile accessory. Separation plates increase the clearance and creepage distances between two modules, thus increasing the rated insulation voltage between two modules to up to 600 V. Double separation plates can be marked with WAD5 or WS10/5 markers and enable continuous cross-connections. Installation is made easier with the perforations to individually break out the cross-connection channels.

- Partition plates visually separates groups from each other
- Indentations for individual breaking out the crossconnection channels
- Partition plates isolates between two modules by increasing the clearance and creepage distances of up to 600 V

General ordering data

Type	TW TXS/TXZ R3.2	Version	
Order No.	1240800000	TERMSERIES, Partition plate	
GTIN (EAN)	4050118028188		
Qty.	10 pc(s).		

Slotted screwdriver



Slotted screwdriver with rounded blade SD DIN 5265, ISO 2380/2, output to DIN 5264, ISO 2380/1. ChromTop tip, SoftFinish grip

General ordering data

Type	SDS 0.6X3.5X100	Version	
Order No.	2749340000	Screwdriver, Blade width (B): 3.5 mm, Blade length: 100 mm, Blade thickness (A): 0.6 mm	
GTIN (EAN)	4050118895568		
Qty.	10 pc(s).		

TRS 60VUC 2CO

Weidmüller Interface GmbH & Co. KG
 Klingenbergstraße 26
 D-32758 Detmold
 Germany

www.weidmueller.com

Accessories

WS 12/6



WS/ DEK

MultiMark terminal markers use an innovative composite material made from two components. The hard base contour of the marker snaps securely into the connector. The elastic surface finish makes the marker easy to mount. This specially punched material enables the strips to be stretched to accommodate the slight variations in spacing that tend to add up, especially with long terminal blocks. Another advantage: the excellent printability of the surface material guarantees durable and wear-resistant labelling. A print resolution of 300 dpi also produces a very legible script.

Your benefits with MultiMark

- Firm hold and durable printing
- Continuous strips save installation time
- Easy mounting thanks to an innovative composite material
- Large label field for optimal legibility
- High flexibility thanks to manufacturer independence

General ordering data

Type	WS 12/6 MM WS	Version
Order No.	2007200000	WS, Terminal marker, 12 x 6 mm, Weidmueller, white
GTIN (EAN)	4050118391886	
Qty.	600 pc(s).	

Crosshead screwdriver Phillips



Crosshead screwdriver, Phillips, SDK PH DIN 5262, ISO 8764/2-PH, output to ISO 8764-PH, ChromTop tip, SoftFinish grip

General ordering data

Type	SDK PH0 X 60	Version
Order No.	2749400000	Screwdriver, Blade width (B): 60 mm, Blade thickness (A):
GTIN (EAN)	4050118895629	
Qty.	1 pc(s).	

TRS 60VUC 2CO

Weidmüller Interface GmbH & Co. KG
 Klingenbergstraße 26
 D-32758 Detmold
 Germany

www.weidmueller.com

Accessories

Crosshead screwdriver Phillips



VDE insulated crosshead screwdriver, for Phillips screws, SDIK PH DIN 7438, ISO 8764/2-PH, output to ISO 8764-PH, SoftFinish grip

General ordering data

Type	SDIK PHO X 60	Version
Order No.	2749880000	Screwdriver, Blade width (B): 60 mm, Blade thickness (A):
GTIN (EAN)	4050118897081	
Qty.	1 pc(s).	

Slotted screwdriver

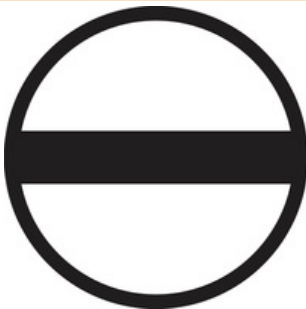

VDE insulated screwdriver sets, for working on live parts up to 1000 V AC and 1500 V DC, DIN EN 60900. IEC 900. Each piece is "GS" safety tested. Blade made from fully hardened, high-alloy chromium-vanadium-molybdenum steel, gun-metal finish.

General ordering data

Type	SDIS SLIM 0.6X3.5X100	Version
Order No.	2749610000	Mounting tool, Blade width (B): 3.5 mm, Blade length: 100 mm, Blade
GTIN (EAN)	4050118896350	thickness (A): 0.6 mm
Qty.	1 pc(s).	

TRS 60VUC 2CO

Weidmüller Interface GmbH & Co. KG
 Klingenbergstraße 26
 D-32758 Detmold
 Germany

www.weidmueller.com

Accessories

Blank



WS markers are the perfect match for the W-series connectors. Thanks to their system compatibility, the WS tags can also be used with the I-series and the Z-series. The large marking surfaces do not only permit long character strings but also multi-line text. WS markers are ideal for labels with long, customised character strings. Thanks to the proven MultiCard format, printing with PrintJet CONNECT oder/or Plotter is possible.

- Can be fitted in strips or individually
- Markers in proven MultiCard format

For custom printing: Please send us a file of our labeling software M-Print PRO or M-Print PRO Online (without installation) for your labeling specifications.

General ordering data

Type	WS 10/12 MC NE WS	Version
Order No.	1905970000	WS, Terminal marker, 10 x 12 mm, Pitch in mm (P): 12.00
GTIN (EAN)	4032248528127	Weidmueller, white
Qty.	300 pc(s).	

Supply module



Space-saving supply modules
 Our supply terminals enable potentials to be fed at the input – e.g. neutral or minus potentials – or switched potentials to be fed at the output. In conjunction with precisely fitting cross-connections from the TEMRSERIES, the connections for the cables on the relay module remain free for actuators or sensors. No additional feed-through terminal blocks are required, resulting in huge space savings in the panel. At the same time, the wiring is simplified as no double wire-end ferrules are required for the potential feed.

General ordering data

Type	TXP SUPPLY	Version
Order No.	2618940000	TERMSERIES, Supply module, Number of contacts: 5, , Continuous current: 10 A, PUSH IN
GTIN (EAN)	4050118667592	
Qty.	10 pc(s).	
Type	TXZ SUPPLY	Version
Order No.	1240790000	TERMSERIES, Supply module, Number of contacts: 5, , Continuous current: 10 A, Tension-clamp connection
GTIN (EAN)	4050118028164	
Qty.	10 pc(s).	

TRS 60VUC 2C0

Weidmüller Interface GmbH & Co. KG

 Klingenbergstraße 26
 D-32758 Detmold
 Germany

www.weidmueller.com

Accessories

Type	TXS SUPPLY	Version
Order No.	1240780000	TERMSERIES, Supply module, Number of contacts: 5, , Continuous
GTIN (EAN)	4050118028140	current: 10 A, Screw connection
Qty.	10 pc(s).	

Cross-connections



Adjustable cross-connections

Increase the flexibility of your cross-connections. The TERMSERIES CROSS-CONNECTION (TCC) enables individually adjustable cross-connections with up to 51 poles. The maximum number of pluggable poles has been increased to 32 poles. The strip material can be shortened to the required length very easily. The cross-connectors convince thanks to their easy handling and visibility as well as their universal connection possibilities. An additional web prevents the spring from deforming during assembly.

- Individually adjustable cross-connection with 51 poles
- Additional bar to avoid deformation of the spring
- Increased cross-connection – up to 32 poles possible
- Vibration resistance

General ordering data

Type	TCC 6.4/51 BL	Version
Order No.	2556450000	TERMSERIES, Cross-connector
GTIN (EAN)	4050118566963	
Qty.	10 pc(s).	
Type	TCC 6.4/2 BL	Version
Order No.	2556430000	TERMSERIES, Cross-connector
GTIN (EAN)	4050118566949	
Qty.	10 pc(s).	
Type	TCC 12.8/26 BK	Version
Order No.	2556500000	TERMSERIES, Cross-connector
GTIN (EAN)	4050118567014	
Qty.	10 pc(s).	
Type	TCC 6.4/2 RD	Version
Order No.	2556390000	TERMSERIES, Cross-connector
GTIN (EAN)	4050118566901	
Qty.	10 pc(s).	
Type	TCC 12.8/26 BL	Version
Order No.	2556460000	TERMSERIES, Cross-connector
GTIN (EAN)	4050118566970	
Qty.	10 pc(s).	
Type	TCC 12.8/26 RD	Version
Order No.	2556420000	TERMSERIES, Cross-connector
GTIN (EAN)	4050118566932	
Qty.	10 pc(s).	
Type	TCC 6.4/51 RD	Version
Order No.	2556410000	TERMSERIES, Cross-connector
GTIN (EAN)	4050118566925	
Qty.	10 pc(s).	

Creation date December 4, 2023 11:41:21 AM CET

TRS 60VUC 2CO

Weidmüller Interface GmbH & Co. KG

Klingenbergstraße 26

D-32758 Detmold

Germany

www.weidmueller.com

Accessories

Type	TCC 6.4/2 BK	Version
Order No.	2556470000	TERMSERIES, Cross-connector
GTIN (EAN)	4050118566987	
Qty.	10 pc(s).	
Type	TCC 6.4/51 BK	Version
Order No.	2556490000	TERMSERIES, Cross-connector
GTIN (EAN)	4050118567007	
Qty.	10 pc(s).	
Type	TCC 6.4/2 OR	Version
Order No.	2556350000	TERMSERIES, Cross-connector
GTIN (EAN)	4050118566826	
Qty.	10 pc(s).	
Type	TCC 6.4/10 BK	Version
Order No.	2556480000	TERMSERIES, Cross-connector
GTIN (EAN)	4050118566994	
Qty.	10 pc(s).	
Type	TCC 12.8/26 OR	Version
Order No.	2556380000	TERMSERIES, Cross-connector
GTIN (EAN)	4050118566697	
Qty.	10 pc(s).	
Type	TCC 6.4/51 OR	Version
Order No.	2556370000	TERMSERIES, Cross-connector
GTIN (EAN)	4050118566680	
Qty.	10 pc(s).	
Type	TCC 6.4/10 RD	Version
Order No.	2556400000	TERMSERIES, Cross-connector
GTIN (EAN)	4050118566918	
Qty.	10 pc(s).	
Type	TCC 6.4/10 OR	Version
Order No.	2556360000	TERMSERIES, Cross-connector
GTIN (EAN)	4050118566673	
Qty.	10 pc(s).	
Type	TCC 6.4/10 BL	Version
Order No.	2556440000	TERMSERIES, Cross-connector
GTIN (EAN)	4050118566956	
Qty.	10 pc(s).	

Drawings

Miscellaneous

Type code TERMSERIES electromechanical relay versions

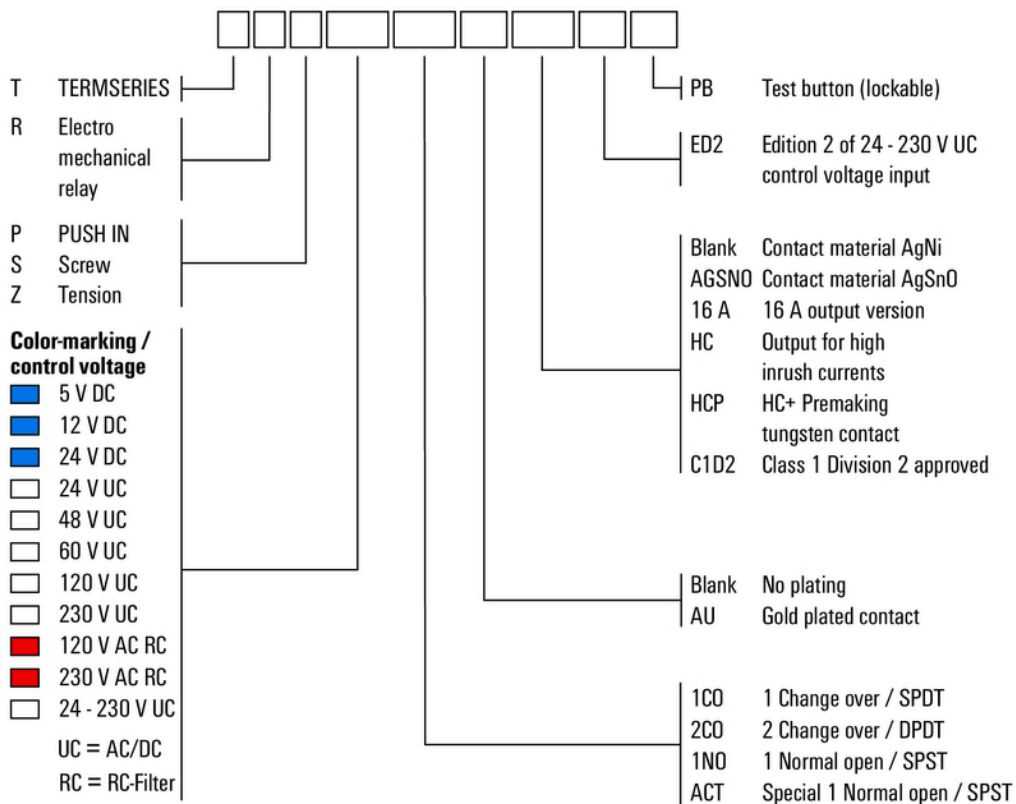

Type codes